

HISTOCORE PELORIS 3

PREMIUM TISSUE PROCESSING SYSTEM

USER MANUAL



CE

Advancing Cancer Diagnostics
Improving Lives

Leica
BIO SYSTEMS

Legal Notices

Intended Use Statement

The HistoCore PELORIS 3 dual retort rapid tissue processor automates preparation of tissue samples for sectioning. This is achieved by transforming fixed specimens into wax infiltrated specimens by exposing them to a sequence of reagents in the tissue processor. Tissue samples subsequently undergo interpretation by a qualified healthcare professional to aid diagnosis.

Copyright and Trademarks

© Leica Biosystems, Melbourne, Australia, 2021. LEICA and the Leica logo are registered trademarks of Leica Microsystems IR GmbH.

45.7512.501 Rev A09 12/2021

HistoCore PELORIS 3, Surgipath, Waxsol, Parablocks, ActivFlo, McCormick and RemoteCare are trademarks of the Leica Biosystems group of companies in the USA and optionally in other countries. Other logos, product and/or company names might be trademarks of their respective owners.

Manufacturer



Leica Biosystems Melbourne Pty Ltd
495 Blackburn Road
Mount Waverley VIC 3149
Australia

Important Information for All Users

Persons operating the HistoCore PELORIS 3 tissue processor **MUST:**



- Follow the instructions for use exactly as described in this user manual. Any deviation from the instructions may result in sub-optimal tissue processing, potential loss of the patient sample and the consequent inability to make a diagnosis.
 - Receive required training to ensure that the instrument is used in accordance with this user manual.
 - Be aware of any potential hazards or hazardous procedures before operating the instrument as described in this user manual.
-

The term "Leica Biosystems" when used in text in this document refers to Leica Biosystems Melbourne Pty Ltd.

The term "PELORIS" when used in text in this document refers to HistoCore PELORIS 3.

Due to a policy of continuous improvement, Leica Biosystems reserves the right to change specifications without notice.

Warranty claims can be made only if the system has been used for the specified application and operated according to the instructions in this document. Damage resulting from inappropriate handling and/or misuse of the product will invalidate the warranty. Leica Biosystems cannot assume liability for any such damage.

Only trained staff are to remove any covers or parts from the processor, and only if instructed within this manual. Repairs must only be carried out by qualified service personnel authorized by Leica Biosystems.

The occurrence of any serious incident(s) that either has led to, or may lead to, death of a patient or user, or the temporary or permanent deterioration in the state of health of a patient or user must be reported to a local Leica Biosystems representative and the relevant local Regulatory Authority.

Revision Record

Rev	Issued	Sections Affected	Detail
A01	August 2017	All	First release
A02	November 2017	All	Minor corrections
A03	February 2018	Consumables and Accessories	Updated Minor corrections
A04	-	-	Not issued
A05	May 2019	Safety Notices , Scanner	Updated
A06	September 2019	Reports , Access Level , Service Settings , Malware Detection	Updated
A07	November 2020	Regulatory Notices	Updated
A08	December 2021	Intended Use Statement , Important Information for All Users , Glossary of symbols , CE Mark , Safety Notices , Introduction , Instrument Decommissioning and Disposal , Electrical , Operating	Updated with new information to support IVDR.
A09	December 2021	Introduction , Hardware , Quick Start , Ancillary Settings & Operations , Data Security and Privacy	Updates throughout, HistoCore I-Scan section added, User Management section added, Chapter 10 updated and renamed to Data Security and Privacy.

Contacting Leica Biosystems

For service or support contact your local representative or see www.LeicaBiosystems.com.

Russian Federation

"BioLine LLC" (Pinsky lane 3 letter A, 197101, Saint Petersburg, the Russian Federation).

e-mail: main@bioline.ru

Tel: (812) 320-49-49

Fax: (812) 320-49-40

Service Hotline: 8-800-555-49-40

Software License Terms

1. Defined terms & interpretation

1.1 Defined terms

In this agreement:

“Leica Biosystems” includes Vision BioSystems Pty Ltd ACN 008 582 401, prior to changing its company name, and Leica Biosystems Melbourne Pty Ltd ACN 008 582 401 after changing its name.

“Confidential Information” means all information:

- a. treated by Leica Biosystems as confidential or of its nature confidential; and
- b. disclosed by Leica Biosystems to the Licensee or of which the other party becomes aware,

except information:

- c. the other party creates independently of Leica Biosystems; or
- d. that is public knowledge (otherwise than as a result of a breach of confidentiality by the Licensee or any of its permitted disclosees).

“Designated Computer” means the computer or microprocessor controlled unit supplied by Leica Biosystems to the Licensee under the Supply Agreement or otherwise recommended for use by Leica Biosystems.

“Documentation” means the manuals, user documentation, proprietary notices, product catalog, website notices and bulletins generally supplied by Leica Biosystems with or relating to the Software.

“Effective Date” means the date the Goods, as defined in the Supply Agreement, are delivered by Leica Biosystems.

“Intellectual Property” means all existing and future intellectual property rights including:

- e. patents, copyright (including all copyright and software), software and associated documentation including the specific design and structure of individual programs, registered designs, trade marks, proprietary documentation and notices, and any right to have information or know-how kept confidential; and
- f. any application or right to apply for registration of any of the rights referred to in **paragraph (e)** above.

“Licensee” means the Purchaser or lessee of the Goods containing the Software, or, where the Licensee is a distributor of the Goods containing the Software, the end user of the Goods containing the Software.

“Licensor IP” means all Intellectual Property relating to:

- a. the Software and Documentation;
- b. any modifications, upgrades, new versions or new releases of the materials referred to in **paragraph (a)** above; and
- c. other works created by Leica Biosystems in the course of, or as a result of, performing this Agreement.

“Release” means each release of a new Version of the Software.”

“Software” means any program, firmware or electronic files that provides instructions or data to a computer or microprocessor and, shall for the purposes of this agreement, include original versions, modified versions, upgrades, updates, bug fixes, and backup copies.

“Supply Agreement” means the agreement between the Licensee and Leica Biosystems, or where the Licensee is not a direct customer of Leica Biosystems, between Leica Biosystems’ distributor and Leica Biosystems, for the sale, lease or use of the Goods.

“Third Party Material” means any Material owned by a third party that is not a Related Body Corporate (as that term is defined in the Corporations Act 2001 (Cth)) of Leica Biosystems.

1.2 Other definitions

In this agreement, “Goods”, “Purchaser”, and “Leica Biosystems” have the same meaning as in the Supply Agreement.

2. Grant of license

2.1 Licensee gives consent

The Licensee agrees to be bound by all the terms of this license by downloading or installing the Software, or by agreeing to purchase, lease or otherwise use the Software or the Goods containing the Software.

2.2 Leica Biosystems grants license

Subject to this agreement, Leica Biosystems grants the Licensee a non-transferable, non-exclusive license to use the Software and Documentation for its internal business purposes in accordance with the terms of this agreement.

3. Restrictions on use

The Licensee must:

- a. only use the Software on the Designated Computer and in conformity with:
 - i. laboratory practices that are consistent with industry practice;
 - ii. all applicable laws, regulations, guidelines and decisions of judicial or regulatory bodies;
 - iii. any patent or other proprietary rights of third parties; and
 - iv. as envisaged by the Documentation, and this agreement;
- b. not install, or procure the installation of, any software on the Designated Computer without Leica Biosystems' prior written consent;
- c. not copy all or part of the Software or Documentation, or allow all or part of the Software or Documentation to be copied (other than one copy of the Software for backup purposes), without obtaining Leica Biosystems' prior written permission;
- d. not publish, distribute or commercialize all or part of the Software or Documentation, or any adaptation, modification or derivative of the Software or Documentation;
- e. not sell, rent, lease, sub-license, assign or transfer all or part of the Software or Documentation or any of its rights under this agreement;
- f. not use the Software or the Documentation for the benefit of any third party, or disclose the Software or the Documentation to any third party, except with Leica Biosystems' prior written consent;

-
- g. not adapt, reverse engineer, make error corrections, or otherwise modify the Software or Documentation or create derivative works based on the Software or Documentation (other than to the extent permitted by applicable copyright laws) or permit third parties to do the same;
 - h. not decompile, decrypt, reverse engineer, disassemble or otherwise reduce the Software to human readable form to gain access to trade secrets or confidential information in the Software or permit third parties to do the same; and
 - i. comply with any reasonable directions of Leica Biosystems from time to time in relation to the installation or use of the Software and the Documentation.

4. Intellectual property

4.1 Licensor IP

All Licensor IP, including but not limited to any images, audio, video and text in the Software, is owned by or licensed to Leica Biosystems, and no Licensor IP is transferred to the Licensee under this agreement.

4.2 Proprietary markings

The Licensee must not alter or remove any notices of proprietary rights, any rights management information or any serial numbers appearing on, attached to or incorporated in Licensor IP or any copies thereof, and must not use or attempt to register any trademark, trade name, business name or company name which is confusingly similar to any trademark or trade name of Leica Biosystems.

4.3 Violations of intellectual property

The Licensee must:

- a. notify Leica Biosystems immediately if it knows of or suspects any unauthorised use, or violation, of any Licensor IP; and
- b. provide promptly, at its cost, all assistance reasonably requested by Leica Biosystems to protect the relevant rights in Licensor IP and prosecute any claims arising from such uses or violations.

4.4 Compliance

The Licensee must comply, at all times, with any terms and conditions relating to the Third Party Material notified to the Licensee by Leica Biosystems and/or the third party supplier of that Third Party Material.

5. Upgrades and support

5.1 New releases and new versions

Leica Biosystems may, at its sole discretion, provide the Licensee with new Releases or new Versions of the Software.

5.2 Installation

If requested by the Licensee to do so, Leica Biosystems, its designated distributor or agent may, at its sole discretion, install a new Release or new Version of the Software on the Designated Computer.

5.3 Downloading of data

Leica Biosystems, or its designated agent may, at its sole discretion, download data that has been generated by the use of the Software by the Licensee as a means of debugging Software faults and otherwise analyzing the performance of the Software or Goods containing the Software supplied by Leica Biosystems under the Supply Agreement.

6. Back up and security of data

It is the Licensee's responsibility to:

- a. perform regular backups of data and to store these; and
- b. provide contingency plans for the event of a failure of any sort (eg: fire, flood, and theft);

and Leica Biosystems has no liability (including for negligence) for any loss whether direct or indirect, that could have been prevented by the Licensee performing the above responsibilities, or which occurs as a consequence of inadequate back up, computer viruses or the ongoing functions of computer hardware (including backup hardware), whether supplied by Leica Biosystems or any other supplier.

7. Confidentiality and privacy

7.1 Use and disclosure

The Licensee must, in relation to the Confidential Information:

- a. keep it confidential;
- b. use it only as permitted under this agreement and only disclose it:
 - i. to employees, contractors and agents that have a need to know and who have undertaken to comply with this clause 7; or
 - ii. to the extent (if any) the Licensee is required by law to do so; and
- c. promptly comply with any request by Leica Biosystems to return or destroy the Confidential Information unless required by law to be retained.

7.2 Recipient's obligations

The Licensee must:

- a. safeguard the Confidential Information from unauthorised access or use; and
- b. notify Leica Biosystems of, and take all steps to prevent or stop, unauthorised copying, use or disclosure.

7.3 Privacy

In performing its obligations under this agreement, the Licensee must comply, and use all reasonable efforts to ensure that its contractors comply, with all applicable legislation relating to privacy of personal information.

8. Exclusions and limitations

8.1 Acknowledgments

The Licensee acknowledges that:

- a. it has selected the Goods from a range of products and has satisfied itself that the Goods meet the Licensee's requirements;
- b. no oral or written information, representation or advice given by or on behalf of Leica Biosystems, other than as contained in this agreement, creates a warranty or in any way increases the scope of this agreement; and
- c. unless expressly agreed otherwise in writing, the Licensee has not relied on any information, representation or advice given by or on behalf of Leica Biosystems in selecting the Goods; and

-
- d. Leica Biosystems makes no representation that the Goods conform to country, state or local laws, ordinances, regulations, codes or standards (except as may otherwise be agreed to in writing by Leica Biosystems) and the Licensee is responsible for complying with all local laws relating to use of the Goods at its own cost.

8.2 Exclusion of implied terms

Leica Biosystems excludes from this agreement all conditions, warranties and liabilities implied or imposed by law or custom except any liability or implied condition or warranty the exclusion or limitation of which would contravene any statute or cause any part of this **clause 8** to be void (**'non-excludable conditions'**).

8.3 Non-excludable conditions

To the extent permitted by law, Leica Biosystems' liability for any breach of any Non-Excludable Condition is limited to:

- a. in the case of services, the resupply of the services or the cost of having the services supplied again (at Leica Biosystems' option); and
- b. in the case of goods, the lowest of the cost of replacing the goods, acquiring equivalent goods or having the goods repaired.

8.4 Exclusion of liability

To the extent permitted by law, Leica Biosystems excludes all liability (including liability for negligence) for:

- a. any indirect or consequential expenses, losses, damages or costs (including, without limitation, loss of profits, loss of revenue, loss of or damage to data, failure to achieve anticipated savings or benefits, and any third party claims) incurred by or awarded against the Licensee under or in any way connected with this agreement or the use of the Software or Documentation;
- b. without limiting the foregoing, any expenses, losses, damages or costs incurred by or awarded against the Licensee arising directly or indirectly in respect of clinical (including without limitation diagnostic, prescription and other treatment) errors made while using, or otherwise associated with the use of, the Software or Documentation; and
- c. the operation or performance of, and any expenses, losses, damages or costs suffered or incurred by the Licensee as a result of its use of, any Third Party Material.

8.5 Limitation of liability

To the extent permitted by law, Leica Biosystems limits its total aggregate liability (including liability for negligence) for any damage arising under or in any way connected with this agreement or the use of the Software to the price paid by the Licensee for the Software or the Goods containing the Software under the Supply Agreement.

9. Indemnity

The Licensee indemnifies Leica Biosystems against all expenses, losses, damages and costs (on a solicitor and own client basis) incurred by or awarded against Leica Biosystems arising directly or indirectly from or in relation to:

- a. any use of the Software not in compliance with this agreement;
- b. any breach of any Third Party license Terms by the Licensee;
- c. the Licensee's infringement of Leica Biosystems' Intellectual Property rights;

-
- d. clinical (including without limitation diagnostic, prescription and other treatment) errors made while using, or otherwise associated with the use, of the Software or Documentation;
 - e. any failure by the Licensee to comply with laboratory practices that are consistent with industry practice, laws, guidelines or decisions in the handling or use of the Software;
 - f. the Licensee's negligent acts or omissions; and/or any other use or misuse of the Software by the Licensee.

10. Term and termination

10.1 Term

This agreement commences on the Effective Date and continues until terminated in accordance with this agreement.

10.2 Termination

- a. The Licensee may terminate this agreement at any time by destroying all copies of the Software and Documentation.
- b. The Licensee's rights under this agreement will terminate immediately without notice from Leica Biosystems if the Licensee fails to comply with any provision of this agreement or if the Licensee does not strictly observe the terms of payment under the Supply Agreement, and on termination, the Licensee must destroy all copies of Software and Documentation in its possession or control.

10.3 Accrued rights and remedies

Termination of this agreement under this **clause 10** does not affect any accrued rights or remedies of either party.

10.4 Survival

Clauses 4 (Intellectual property), **7** (Confidentiality and privacy), **8** (Exclusions and limitations), **9** (Indemnity), **10.3** (Accrued rights and remedies), **10.4** (Survival), **11** (Force majeure) and **12** (General) continue after termination of this agreement.

11. Force majeure

Neither party will be liable for any delay or failure to perform its obligations pursuant to this agreement (other than on obligation to pay money) if that delay is due to Force Majeure. If a delay or failure of a party to perform its obligations is caused by or anticipated due to Force Majeure, the performance of that party's obligations will be suspended. Either party may terminate this agreement if a Force Majeure persists for a continuous period of 90 days.

12. General

12.1 Severance

Part or all of any provision of this agreement that is illegal or unenforceable may be severed from this agreement and the remaining provisions will continue in force.

12.2 Entire agreement

This agreement (including any additional terms notified to the Licensee by Leica Biosystems) constitutes the entire agreement between the parties and supersedes any prior representations, warranties, understandings or agreements that relate to the same subject matter.

12.3 Variation

This agreement may only be amended by agreement in writing between the parties.

12.4 Governing law

This agreement is governed by the laws of the State of Victoria, Australia, and the parties submit to the non-exclusive jurisdiction of the courts in that State.

Safety Notices

The PELORIS 3 tissue processor is designed to provide safe, trouble-free operation when used in accordance with this document. Follow all safety precautions to avoid personal injury, damage to patient samples, and damage to the instrument. Clean and maintain the instrument as described in [Chapter 7 - Cleaning and Maintenance](#).

The Safety Notice Types section below describes the types of safety notices in the manual.

The General Warnings and Cautions section has general warnings for the PELORIS 3 instrument. Other notices appear in relevant sections in the manual.

Types of Safety Notice

Safety notices in this manual are either warnings or cautions.

Warnings

Warnings are notifications of hazards that could lead to personal injury to PELORIS 3 users or people in the vicinity of the instrument.

Warnings are also used when there is the possibility of damaging patient tissue samples.

Warnings use symbols with a black border and yellow background, as illustrated below:



TOXIC HAZARD

There is danger of ingestion, inhalation or skin contact with toxic material.



HEAT HAZARD

There is danger of burns.



CHEMICAL HAZARD

There is a danger of exposure to corrosive chemicals.



ELECTRICAL HAZARD

There is danger of electric shock.



FLAMMABLE HAZARD

Flammable hazard. Flammable reagents may ignite if proper precautions are not followed.



BIOLOGICAL HAZARD

Biological hazard. There is a danger of severe health impacts if proper precautions are not followed.



GENERAL HAZARD

There is danger of personal injury or damage to patient tissue samples.

Cautions

Cautions are notifications of hazards that could lead to damage to the PELORIS 3 instrument or other equipment.

Cautions in this manual use symbols with a black border and white background, as illustrated below:



CAUTION: There is danger of damage to the PELORIS 3 instrument or other equipment.

General Warnings and Cautions

Persons operating the PELORIS 3 must be fully aware of the following warnings, in order to mitigate possible tissue damage or loss.

Reagent Configuration



WARNING: Always ensure that the reagents configured in the software are the actual reagents loaded on the instrument.
A station containing different reagent could damage tissue samples.

Replacing Reagents



WARNING: Always change reagents when prompted.
Always update station details correctly – never update the details without replacing the reagent.
Failure to follow these directives can lead to tissue damage or loss.



WARNING: Do not alter the concentration of a used reagent unless you are able to verify the actual concentration. If the concentration is incorrect a reduction in tissue processing quality or damage to the tissue sample may result.

Protocol Validation



WARNING: Do not set new protocols as validated until they have passed the validation procedures for your laboratory. Only then should you edit the protocol to set it as valid, making it available to operators for clinical use (see [4.1.4 - Protocol Validation](#)). Use of non-validated protocols may result in tissue damage or loss.

Basket and Cassette Loading



WARNING: Always ensure the cassettes are correctly inserted into the baskets and that the baskets are correctly placed in the retorts. Incorrectly placed cassettes or baskets may lead to samples being damaged as some tissue may not be fully covered by reagent during processing (see [2.2.4 - Cassette Baskets](#)).



WARNING: Never place three baskets into a retort when the instrument is configured with a two-basket fill level. If this occurs, reagent will not cover the top basket and tissue samples will be damaged.

Cleaning Protocol



WARNING: Remove all tissue from the retort before running a cleaning protocol as the dry step will damage the tissue.



WARNING: Do not use cleaning protocols for reprocessing as the dry step will damage the tissue.



WARNING: Do not load unprocessed tissue samples into a retort prior to running a cleaning protocol. Formalin in the residue purged to the wax bath at the start of the cleaning run may damage tissue on subsequent runs.
If you inadvertently load unprocessed samples into a retort prior to running a cleaning protocol, remove the samples and attempt to load a processing protocol before loading the cleaning protocol. The purge before the cleaning run will be skipped.

Instrument Setup



WARNING: Do not use the instrument without installing the drip tray.



WARNING: The instrument must be installed and configured by an approved service representative.



WARNING: PELORIS 3 does not require network access to function and perform its intended use. To prevent malicious or unauthorized access, install PELORIS 3 without any connection to your network / infrastructure.



WARNING: Always use suitably rated lifting equipment (such as a trolley or forklift) when moving a PELORIS 3 tissue processor more than a few yards.
Only use the instrument's castors to reposition an instrument for service access.



WARNING: When the vapor select valve is in the external position, you must ensure an external vapor system is correctly installed; otherwise potentially dangerous fumes will be released into the laboratory environment.

Electrical Hazards



WARNING: The PELORIS 3 tissue processor must be connected to an earthed mains power outlet socket.



WARNING: Dangerous voltages are present inside the PELORIS 3 tissue processor. Only service technicians approved by Leica Biosystems should remove any of the instrument's covers or access the internal components.



WARNING: The instrument's operating voltage is factory set and it must not be changed. Severe damage will occur if an instrument is connected to an incorrect power supply voltage.



WARNING: Do not pull out the mains cable whilst the instrument is operating unless there is an emergency situation and both the front panel power button and the mains wall switch are inaccessible.



WARNING: Locate the instrument so that either the mains wall outlet or the instrument's appliance inlet socket is accessible. You must be able to disconnect the mains power cable without moving the instrument.



WARNING: Do not move the instrument unless the power cable is disconnected.

Reagents



WARNING: Chloroform vapors may cause severe injury, incapacitation, or death. When using chloroform with the PELORIS 3 tissue processor, Leica Biosystems recommends that an external fume extraction system be installed. Chloroform vapors may accumulate during normal operation or in the unlikely event of a spill. The extraction system must keep these vapors below dangerous levels. Never open a retort that contains chloroform or chloroform residue.



WARNING: Do not heat reagents above their boiling points. Boiling reagents will release large quantities of fumes that may overload the internal carbon filter or (if fitted) the external filtering system. Boiling reagents are also likely to lead to excessive pressures within the instrument, increased reagent contamination and reagent spills. Reagent boiling points are lower when in a retort operating with a vacuum or with pressure/vacuum cycling.



WARNING: Handle and dispose of reagents and condensate in accordance with all relevant procedures and government regulations that apply at the laboratory site.



WARNING: Do not use fixatives containing picric acid as picric acid is explosive when dry.



WARNING: Molten wax is hot and may cause burns. Use caution when handling wax and removing baskets.



CAUTION: Do not use acetone or other ketones. These damage the instrument's valves.



CAUTION: Do not use reagents containing corrosive chemicals such as mercuric salts, picric acid, nitric acid and hydrochloric acid.

Regulatory Notices

In Vitro Diagnostics Symbol



FCC Compliance

This equipment has been tested and found to comply with the limits for a Class A digital device, pursuant to part 15 subpart B of the FCC Rules. These limits are designed to provide reasonable protection against harmful interference when the equipment is operated in a commercial environment. This equipment generates, uses, and can radiate radio frequency energy and, if not installed and used in accordance with the instruction manual, may cause harmful interference to radio communications. Operation of this equipment in a residential area is likely to cause harmful interference in which case the user will be required to correct the interference at his own expense.

To maintain compliance use only the cables supplied with the instrument.

Warning: Any changes or modifications not expressly approved by Leica Biosystems could void the user's authority to operate this equipment.

CE Mark



The CE Mark signifies compliance with the applicable EU Directives as listed on the manufacturer declaration of conformity.

Declaration of Conformity

A "Declaration of Conformity" in accordance with the preceding directives and standards has been made and is on file at Leica Biosystems Melbourne Pty Ltd, 495 Blackburn Road, Mount Waverley, Victoria 3149, Australia.

Instructions for in vitro diagnostic equipment for professional use

This IVD equipment complies with the emission and immunity requirements of IEC 61326 part 2-6.

Warning: This equipment was designed and tested to CISPR 11 Class A. In a domestic environment it may cause radio interference, in which case you may need to take measures to mitigate the interference.

The electromagnetic environment should be evaluated prior to operation of the device.

Do not use this device in close proximity to sources of strong electromagnetic radiation (e.g. unshielded intentional RF sources), as these can interfere with the proper operation.

Caution: Federal Law restricts this device to sale by or on the order of a licensed healthcare practitioner.

Standards

IEC 61010-1	Safety requirements for electrical equipment for measurement, control and laboratory use – Part 1 General requirements
UL 61010-1	Safety requirements for electrical equipment for measurement, control and laboratory use – Part 1 General requirements

CAN/CSA C22.2 No. 61010-1	Safety requirements for electrical equipment for measurement, control and laboratory use – Part 1 General requirements
IEC 61010-2-010	Safety requirements for electrical equipment for measurement, control and laboratory use – Part 2 Particular requirements for the heating of materials
IEC 61010-2-081	Safety requirements for electrical equipment for measurement, control and laboratory use – Part 2 Particular requirements for automatic and semi-automatic laboratory equipment for analysis and other purposes
IEC 61326-1	Electrical equipment for measurement, control and laboratory use – EMC requirements – Part 1 General requirements
IEC 61326-2-6	Electrical equipment for measurement, control and laboratory use – EMC requirements – Part 2-6 In Vitro diagnostic (IVD) medical equipment
FCC Part 15 Subpart B	Class A Unintentional Radiators
ISO 13485	Medical Devices – Quality management systems – Requirements for regulatory compliance

Computer regulatory requirements: UL Listed (UL 60950), IEC 60950 certified.

Glossary of symbols

Regulatory symbols

Explanation of the regulatory symbols used for Leica Biosystems products.















Note: This glossary provides images of the symbols as presented in the relevant standards, however, some of the symbols may vary in color.



The following is a list of symbols used on the product labeling and their meaning.

ISO 15223-1

Medical devices – symbols to be used with medical device labels, labeling and information to be supplied – Part 1: General requirements



Symbol	Standard/ Regulation	Reference	Description
	ISO 15223-1	5.1.1	Manufacturer Indicates the medical device manufacturer.
	ISO 15223-1	5.1.2	Authorized representative in the European community Indicates the Authorized representative in the European Community.

Symbol	Standard/ Regulation	Reference	Description
	ISO 15223-1	5.1.3	Date of manufacture Indicates the date when the medical device was manufactured.
	ISO 15223-1	5.1.4	Use by (expiration date) Indicates the date after which the medical device is not to be used.
	ISO 15223-1	5.1.5	Batch code Indicates the manufacturer's batch code so that the batch or lot can be identified.
	ISO 15223-1	5.1.6	Catalog number / Reference number Indicates the manufacturer's catalog number so that the medical device can be identified.
	ISO 15223-1	5.1.7	Serial number Indicates the manufacturer's serial number so that a specific medical device can be identified.
	ISO 15223-1	5.3.1	Fragile; handle with care Indicates a medical device that can be broken or damaged if not handled carefully.
	ISO 15223-1	5.3.4	Keep away from rain Indicates that the transport package shall be kept away from rain and in dry conditions.
	ISO 15223-1	5.3.7	Temperature limit Indicates the temperature limits to which the medical device can be safely exposed.
	ISO 15223-1	5.4.2	Do not re-use Indicates a medical device that is intended for one use, or for use on a single patient during a single procedure.
	ISO 15223-1	5.4.3	Consult instructions for use Indicates the need for the user to consult the instructions for use.
	ISO 15223-1	5.4.4	Caution Indicates the need for the user to consult the instructions for use for important cautionary information such as warnings and precautions that cannot, for a variety of reasons, be presented on the medical device itself.

Symbol	Standard/ Regulation	Reference	Description
	ISO 15223-1	5.5.1	In Vitro Diagnostic medical device Indicates a medical device that is intended to be used as an in vitro diagnostic medical device.
	ISO 15223-1	5.1.8	Importer Indicates the entity importing the medical device into the European Union.





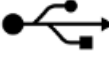
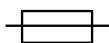

ISO 7000

Graphical symbols for use on equipment — Registered symbols.

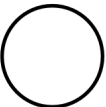
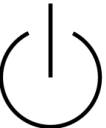



Symbol	Standard/ Regulation	Reference	Description
	ISO 7000	1135	Recycle Indicates that the marked item or its material is part of a recovery or recycling process.
	ISO 7000	1640	Technical manual; manual for service Identifies the location where the handbook is stored or to identify information that relates to the servicing instructions for the equipment. To indicate that the service manual or handbook should be considered when servicing the device close to where the symbol is placed.
	ISO 7000	2594	Ventilation open Identifies the control that allows outside air into interior environment.
	ISO 7000	3650	USB Identifies a port or plug as meeting the generic requirements of the Universal Serial Bus (USB). To indicate that the device is plugged into a USB port or is compatible with a USB port.
	ISO 7000	5016	Fuse Identifies fuse boxes or their location.







IEC 60417

Graphical symbols for use on equipment.

Symbol	Standard/ Regulation	Reference	Description
	IEC 60417	5007	On Indicates connection to the mains, at least for mains switches or their positions, and all those cases where safety is involved
	IEC 60417	5008	Off Indicates disconnection from the mains, at least for mains switches or their positions, and all those cases where safety is involved
	IEC 60417	5009	Stand-by Identifies the switch or switch position by means of which part of the equipment is switched on in order to bring it into the standby condition
	IEC 60417	5019	Protective earth: protective ground A terminal that is intended for connection to an external conductor for protection against electric shock in case of a fault, or the terminal of a protective earth (ground) electrode.
	IEC 60417	5032	Single phase alternating current Indicates on the rating plate that the equipment is suitable for alternating current only; to identify relevant terminals.
	IEC 60417	5134	Electrostatic Sensitive Devices Packages containing electrostatic sensitive devices, or a device or a connector that has not been tested for immunity to electrostatic discharge.
	IEC 60417	6040	Warning: Ultraviolet radiation Alert for the presence of UV light within the product's enclosure that may be of sufficient magnitude to constitute a risk to the operator. Turn off the UV lamp before opening. Use UV radiation eye and skin protection during servicing.
	IEC 60417	6057	Caution: moving parts An instructional safeguard to keep away from moving parts.
	IEC 60417	6222	Information; general Identifies the control to examine the status of the equipment, e.g. multifunctional copying machines

Other symbols and markings

Symbol	Standard/ Regulation	Reference	Description
	21 CFR 801.15 (c)(1)(i)F		<p>Prescription only</p> <p>Recognized by the US FDA as an alternate to "Caution: Federal law restricts this device to sale by or on the order of a licensed practitioner."</p>
	The instrument Declaration of Conformity lists the Directives with which the system complies		<p>European Conformity</p> <p>The CE Mark of conformity signifies that the system complies with applicable EU Directives. The instrument Declaration of Conformity lists the Directives with which the system complies.</p>
	Directive 2012/19/EC EU: waste electrical and electronic equipment (WEEE)		<p>Waste Electrical and Electronic Equipment (WEEE) Directive</p> <p>The electronic product should not be discarded as unsorted waste but must be sent to separate collection facilities for recovery and recycling.</p> <p>The presence of this label indicates that:</p> <ul style="list-style-type: none"> • The device was put on the European Market after August 13, 2005. • The device is not to be disposed of via the municipal waste collection system of any member state of the European Union. <p>Customers must understand and follow all laws regarding the correct decontamination and safe disposal of electrical equipment.</p>
	AS/NZS 4417.1		<p>Regulatory Compliance Mark (RCM)</p> <p>Indicates compliance with the Australian Communications Media Authority (ACMA) requirements (safety and EMC) for Australia and New Zealand.</p>
	People's Republic of China Electronic Industry Standard SJ/T11364		<p>Restriction of Hazardous Substances (RoHS 2)</p> <p>Indicates that this electronic information product contains certain toxic or hazardous elements, and can be used safely during its environmental protection use period. The number in the middle of the logo indicates the environmental protection use period (in years) for the product. The outer circle indicates that the product can be recycled. The logo also signifies that the product should be recycled immediately after its environmental protection use period has expired. The date on the label indicates the date of manufacture.</p>

Symbol	Standard/ Regulation	Reference	Description
	People's Republic of China Electronic Industry Standard SJ/T11364		Restriction of Hazardous Substances (RoHS 2) Indicates that this electronic information product does not contain any hazardous substances or they do not exceed the concentration limits specified in GB/T 26572. It is a green environmentally friendly product that can be recycled.
	Title 47 United States Code of Federal Regulations Part 15		Federal Communications Commission (FCC) This product has been tested and found to comply with the limits pursuant to part 15 of the FCC Rules.
	N/A		Underwriters Laboratory (UL) certification mark Underwriter Laboratories have certified that the listed products complies with both US and Canadian safety requirements.
	CSA International		Listed device with CSA Group testing agency CSA Group have certified that the listed products complies with both U.S and Canadian safety requirements.
	N/A		Listed device with Intertek testing agency Intertek Testing Agency have certified that the listed products complies with both U.S and Canadian safety requirements.
	N/A		Unconnected port This product has an unconnected port on the syringe pump.

Safety symbols

Explanation of the safety symbols used for Leica Biosystems products.

ISO 7010

Graphical symbols — Safety colors and safety signs — Registered safety signs

Symbol	Standard/ Regulation	Reference	Description
	ISO 7010	W001	General warning Indicates the need for the user to consult the instructions for use for important cautionary information such as warnings and precautions that cannot, for a variety of reasons, be presented on the medical device itself.

Symbol	Standard/ Regulation	Reference	Description
	ISO 7010	W004	Warning: laser beam Laser hazard. Potential for severe eye damage. Avoid direct eye contact with laser beams.
	ISO 7010	W009	Warning: biological hazard Biological hazard. Potential exposure to a biological hazard. Follow directions in the accompanying documentation to avoid exposure.
	ISO 7010	W012	Caution: risk of electric shock Electrical hazard. Potential risk of electric shock. Follow directions in the accompanying documentation to avoid damage to persons or equipment.
	ISO 7010	W016	Warning: toxic material Toxic hazard. Potential danger of severe health impacts if proper chemical handling procedures are not followed. Use gloves and protective eye wear when handling reagents.
	ISO 7010	W017	Warning: hot surface Heat hazard. Hot surfaces will cause burns if touched. Avoid touching parts identified with this symbol.
	ISO 7010	W021	Warning: flammable material Flammable hazard. Flammable materials may ignite if proper precautions are not followed.
	ISO 7010	W023	Warning: corrosive substance Chemical hazard from a corrosive substance. There is a danger of severe health impacts if proper precautions are not followed. Always wear protective clothing and gloves. Immediately clean up spills using standard laboratory practice.
	ISO 7010	W024	Warning: crushing of hands Crush hazard. Hands or body parts can be crushed by a closing motion of mechanical parts of equipment.

This page is intentionally left blank.

Table of Contents

Legal Notices	2
Software License Terms	4
Safety Notices	11
Regulatory Notices	16
Glossary of symbols	17
1. Introduction	5
1.1 Summary of Chapters	6
1.2 Using the Software	6
1.2.1 Basic Operation	7
1.2.2 Navigation	8
1.2.3 Access Levels	10
1.3 Help	11
2. Hardware	12
2.1 Switching On and Shutting Down	14
2.2 Retorts	15
2.2.1 Opening and Closing Retort Lids	15
2.2.2 Fill Levels	16
2.2.3 Magnetic Stirrer	17
2.2.4 Cassette Baskets	18
2.3 Wax Bath	21
2.4 Reagent Cabinet	22
2.4.1 Reagent Bottles	22
2.4.2 Condensate Bottle	23
2.4.3 Carbon Filter	23
2.5 Touch-screen	23
2.6 Scanner	24
2.6.1 Barcode Scanner	24
2.6.2 HistoCore I-Scan	25
2.7 USB Ports	27
2.8 External Vapor Removal Systems	28
2.8.1 Connecting to an External System	28
2.8.2 Returning to the Internal Filter System	29
2.9 Alarm Connections	30
2.9.1 Alarm Connector Specifications	30
2.9.2 Alarm Connector Pins	30
2.9.3 Pin Schematic During Normal Operation	31
2.9.4 Pin Schematic During Alarm Conditions	31
2.10 Instrument Decommissioning and Disposal	31

3. Running Protocols	32
3.1 Quick Start	33
3.2 Cleaning Protocols	39
3.2.1 Cleaning Laboratory Implements	40
3.2.2 Modifying Cleaning Protocols for Different Retort Residues	40
3.2.3 Pre-cleaning Purges	41
3.3 Status Screen	42
3.3.1 Status Area	43
3.3.2 Protocol Panels	48
3.4 Protocol Run Options	49
3.4.1 Scheduling Protocols	49
3.4.2 Changing the Starting Step for a Single Run	53
3.4.3 Changing the Step Time for a Single Run	54
3.5 Pausing and Abandoning Protocols	55
3.5.1 Emergency Stop and Abandon	56
3.5.2 Access Retort	56
3.5.3 Recovering from an Abandoned Run	57
3.6 Retort Scheduling	58
3.6.1 Delayed End Times and Initial Fills	58
3.6.2 Unavoidable Reagent Clashes	58
3.6.3 Unavailable Reagents	59
4. Protocol Setup	60
4.1 Protocol Overview	60
4.1.1 Protocol Types	61
4.1.2 Reagent Selection Method	61
4.1.3 Pre-defined Protocols	63
4.1.4 Protocol Validation	63
4.1.5 Carryover Setting	64
4.1.6 Protocol Files	66
4.2 Creating, Editing and Viewing Protocols	67
4.2.1 Protocol Selection Screen	67
4.2.2 Editing Protocols	69
4.2.3 Creating New Protocols	73
4.2.4 Viewing Protocols	75
5. Reagent Setup	76
5.1 Overview	77
5.1.1 Reagent Groups, Types and Stations	77
5.1.2 Concentration Management	79
5.1.3 Thresholds	80
5.1.4 Recommended Reagents	83
5.1.5 Non-recommended Reagents	84
5.1.6 Tissue Marking	85
5.1.7 Reagent Compatibility	85
5.2 Managing Reagent Types	86

5.2.1	Pre-defined Reagents	86
5.2.2	Editing Active Reagent Types	87
5.2.3	Adding, Hiding and Deleting Reagents	90
5.3	Managing Reagent Stations	92
5.3.1	Reagent Stations Screen	93
5.3.2	Setting Reagent Station Properties	95
5.4	Replacing Reagents	98
5.4.1	Remote Fill/Drain Screen	99
5.4.2	Remote Fill/Drain Connections	100
5.4.3	Replacing Reagent – Remote Fill and Drain	102
5.4.4	Replacing Reagent - Manually	105
5.4.5	Replacing Wax	106
5.4.6	Filling and Draining Retorts	109
6.	Ancillary Settings & Operations	110
6.1	Reagents Menu	111
6.1.1	Manual Operations	111
6.2	Admin Menu	114
6.2.1	Reports	114
6.2.2	Event Logs	119
6.2.3	Access Level	121
6.2.4	User Management	122
6.3	Settings Menu	125
6.3.1	Service Settings	125
6.3.2	Reagent Management	128
6.3.3	Instrument Settings	131
6.3.4	Device Settings	133
6.3.5	Alarms	134
7.	Cleaning and Maintenance	136
7.1	Cleaning and Maintenance Tools	136
7.1.1	Wax scraper	137
7.1.2	LLS cleaning tool and wax vent plug	138
7.2	Maintenance Screen	139
7.3	Cleaning and Maintenance Schedule	140
7.3.1	Daily	140
7.3.2	Weekly	140
7.3.3	60–90 Days	140
7.3.4	As Required	140
7.3.5	PELORIS 3 User Maintenance Chart	141
7.3.6	Daily Tasks	142
7.3.7	Weekly Tasks	148
7.3.8	60–90 Days	150
7.3.9	Retort Acid Clean	153
8.	Reference	154
8.1	Reagent Threshold Guidelines	154

8.1.1	Xylene Processing	154
8.1.2	Xylene-free Processing	155
8.2	Protocols	156
8.2.1	Specimen Type and Protocol Duration	156
8.2.2	List of Pre-defined Protocols	157
8.2.3	Xylene Protocols	158
8.2.4	Xylene-free Protocols	163
8.2.5	Cleaning Protocol	166
8.3	Station Configurations	167
8.3.1	Xylene Configuration	167
8.3.2	Xylene-free Configuration	168
8.4	Protocol Step Temperatures	169
8.5	Reagent Compatibility Tables	170
8.5.1	Manual Operations	170
8.5.2	Standard Protocols	170
8.5.3	Xylene-free Protocols	170
8.5.4	Cleaning Protocols	171
9.	Troubleshooting	172
9.1	Preliminary Questions	173
9.2	Flowcharts	173
9.2.1	Under-processed Tissue – Instrument Setup	174
9.2.2	Over-processed Tissue – Instrument Setup	175
9.2.3	Under- or Over-processed Tissue – Reagents	176
9.2.4	Poor Processing – Incorrect Protocol	177
9.2.5	Poor Processing – Correct Protocol	178
9.2.6	Cutting Artifact	179
9.2.7	Staining Artifact	180
9.2.8	Block Artifact	181
9.3	Reprocessing Recommendations	182
10.	Data Security and Privacy	185
10.1	Malware Detection	185
10.2	Statement for User Data Security and Privacy	185
11.	Specifications	186
Index	188

1. Introduction

The HistoCore PELORIS 3 (hereafter PELORIS 3) is a rapid dual-retort tissue processor that offers fast, high quality tissue processing for histology laboratories. With reagent capacity sufficient to run the two retorts independently, it allows a high degree of scheduling flexibility. Intelligent software lets you configure the instrument to suit your laboratory's workflows while providing checks and restrictions that help you avoid mistakes that could damage tissue. Density meters ensure that the concentration of reagents on first use is accurate and a sophisticated reagent management system closely tracks reagent condition.

The intended users of the PELORIS 3 instrument are adequately trained laboratory personnel.

Depending on your setup, the PELORIS 3 uses this information to select the optimal reagent for each protocol step. It alerts you when to replace reagent, so that quality is never compromised, while at the same time ensuring you get full use of all reagents.

The clear, intuitive, touch-screen interface makes loading runs and monitoring them easy. Protocol configuration, reagent setup and other system settings are equally straightforward. And behind all this you have the support of Leica Biosystems, with years of experience developing top quality, industry-leading histology equipment.

Congratulations on your purchase of the PELORIS 3 Premium Tissue Processing System. We trust it will provide you with years of fast, efficient, high quality tissue processing.

This chapter has the following sections:

- [1.1 - Summary of Chapters](#)
- [1.2 - Using the Software](#)
- [1.3 - Help](#)

1.1 Summary of Chapters

- [1 - Introduction](#): general introduction, chapter summary, general instructions for using the software, and help resources.
- [2 - Hardware](#): descriptions of the main components of the PELORIS 3.
- [3 - Running Protocols](#): main steps for running protocols, further configuration options and scheduling, and monitoring processing on the Status screen.
- [4 - Protocol Setup](#): descriptions of protocol types and the reagent selection methods used, protocol validation and the carryover setting. Creating and editing protocols.
- [5 - Reagent Setup](#): reagent groups, types and stations, and reagent management. Setting up reagent types and stations in the software. Replacing reagents.
- [6 - Ancillary Settings & Operations](#): basic instrument settings, manual operation of instrument components, event monitoring, alarms, and transfer of system files.
- [7 - Cleaning and Maintenance](#): daily and as-required maintenance, and accessories available from Leica Biosystems.
- [8 - Reference](#): descriptions of the pre-defined protocols and recommended bottle configurations. Recommended reagent thresholds and reagent compatibility tables.
- [9 - Troubleshooting](#): questions, flowcharts and scenarios to assist with problem solving.
- [10 - Data Security and Privacy](#): information about data security and privacy and the anti-malware scanner.
- [11 - Specifications](#): system specifications.

1.2 Using the Software

You control all instrument functions from the touch-screen. This section describes basic touch-screen operation and how to navigate the software, with a summary of all the software screens. It also describes user access levels.

This section has the following sub-sections:

- [1.2.1 - Basic Operation](#)
- [1.2.2 - Navigation](#)
- [1.2.3 - Access Levels](#)

1.2.1 Basic Operation

1.2.1.1 Buttons

Tap buttons on the touch-screen to open menus, screens and dialogs, and to start and stop actions. The state of a button is indicated by its color or border. Depending on the screen and the operations available, enabled buttons could be dark gray, bright blue, bright pink or bright green. Disabled buttons are light versions of the base color. Selected buttons have a blue border.

Figure 1-1: Sample button states: selected, enabled, disabled



Buttons in a toggle pair are dark gray and bright blue.

1.2.1.2 Icons

Icons are used to represent various elements of the PELORIS 3, such as reagent stations and retorts. Selectable icons appear raised. Select an icon by tapping it, as you would a button. A selected icon appears raised with a blue outline.

Figure 1-2: Reagent station: selectable and selected



1.2.1.3 Keypads

Keypads appear as needed to allow you to enter text and numbers. There are two types: alphanumeric (text and numbers) and numeric (numbers only). The keypads are analogous to a computer keyboard with on-screen buttons acting as keys (1). Enter text and numbers by tapping the appropriate buttons in order. Use the **Caps Lock** button (4) or **Shift** button (5) to select upper or lower case characters. As you type, the characters you select are displayed in the text window (6). The alphanumeric keypad has a **Back Space** button (7) to delete the last character while all keypads include a **Clear** button (3) to remove all characters. When you have finished, tap the **Esc** button (2) to exit without saving or the **Enter** button (8) to confirm your entry.

Figure 1-3: Alphanumeric keypad



1.2.2 Navigation

You navigate throughout the software from the Function bar at the top of the screen.

Figure 1-4: The Function bar

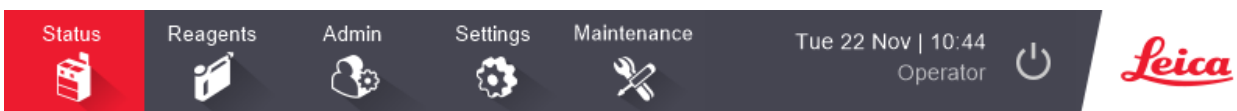

The Function bar is always visible, so you can always find the screen you want. Tap a button in the Function bar to open either a screen or a menu with options for related screens.

Some screens have alternative views to divide the information presented. For example, the Reagent Stations screen has two views, one for bottle information and the other for wax chamber information. Tap buttons on these screens to move between the alternative views.

In this manual, navigation paths are shown in this way:

A > B > C

This means from the Function bar button, tap **A**, then tap **B** and finally tap **C**. For example, **Admin > Protocols > Load** means tap the **Admin** button on the Function bar, tap **Protocols** (which will be on the **Admin** menu) and then tap **Load** (which will be a button on the **Protocol Selection** screen).

Figure 1-5: Sample navigation path

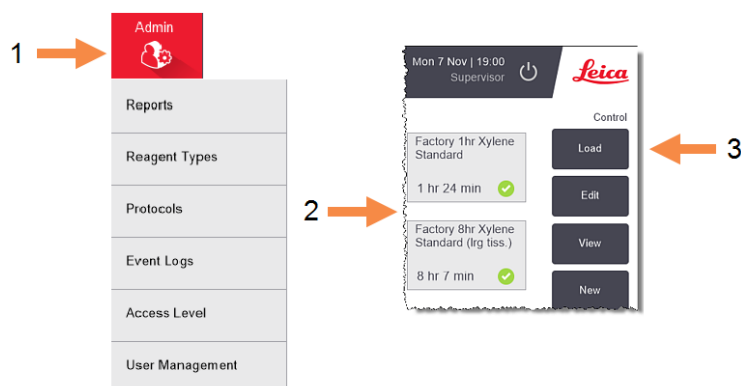

[Table 1-1](#) below lists all the screens in the PELORIS 3 software with brief a description of their function. There are also links to relevant sections of this manual.

Table 1-1: Buttons, menus and screens







Function bar button	Menu button	Screen purpose	Refer to:
Status 	—	Load and run protocols, and view system status.	3.3 - Status Screen
Reagents 	Stations	Set up reagent stations. You can also view the current reagent concentrations and wax bath temperatures.	5.3 - Managing Reagent Stations
	Remote Fill/Drain	Fill or drain reagent bottles and drain wax stations.	5.4 - Replacing Reagents
	Manual Operations	Manually control individual instrument components.	6.1.1 - Manual Operations
Admin 	Reports	Choose from one of four reports regarding run details, user actions, protocol use and reagent use.	6.2.1 - Reports
	Reagent Types	Manage your list of active reagent types.	5.2 - Managing Reagent Types
	Protocols	Select, create, edit and manage protocols.	4.2 - Creating, Editing and Viewing Protocols
	Event Logs	View all system events.	6.2.2 - Event Logs
	Access level	Set the access level	6.2.3 - Access Level
	User Management	Create users and manage user details and access levels	6.2.4 - User Management

Table 1-1: Buttons, menus and screens (continued...)

Function bar button	Menu button	Screen purpose	Refer to:
Settings 	Service	View the instrument serial number and software versions, transfer log files and incident reports, and export or import protocol files.	6.2.2 - Event Logs
	Reagent Management	Set basic reagent management options.	6.3.2 - Reagent Management
	Instrument	Set options for time display, the carbon filter, fill levels and manual operation drip time.	6.3.3 - Instrument Settings
	Device	Change sound and alarm settings, and lock the touch-screen.	6.3.4 - Device Settings
	Alarms	Clear or silence active alarms.	6.3.5 - Alarms
Maintenance 	—	Record that various maintenance tasks have been completed.	7.2 - Maintenance Screen
	—	Close the PELORIS software.	2.1 - Switching On and Shutting Down
	—	Open an HTML5 version of the user manual in the PELORIS 3 software.	1.3 - Help

1.2.3 Access Levels

PELORIS 3 has two user-access levels available to laboratory staff: operator and supervisor. Operators can carry out all routine tasks, such as running protocols and replacing reagents. However, operators cannot edit protocols or set bottle configurations: you must have supervisor rights for these actions. Supervisors also have rights to configure the system.

Some configuration settings displayed in the software require service-level access to change. These are provided so you can view the settings, but you must contact your customer support representative if you want to change them.

You automatically begin at operator level when you start the software. Supervisors need to enter a password to gain access to supervisor-only functions. (Go to **Admin > Access Level** to enter the supervisor password.) If a supervisor does not interact with the software for more than 10 minutes at any one time, the access level automatically reverts to operator. The instrument requires and forces passwords to be changed every 90 days and the previous 10 passwords cannot be reused.

A label on the Function bar indicates your current access level.

Figure 1-6: Access level label showing Operator access

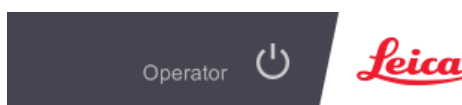

1.3 Help

This user manual is provided in PDF format on a CD. It is also included (in HTML5 format) in the PELORIS 3 software. Tap the **Leica** logo in the Function bar to open it. Use buttons on the **Help** screen and links in the text to navigate through the Online Help.

2. Hardware

The PELORIS 3 tissue processor is a free-standing processor with two retorts, sixteen reagent bottles and four wax chambers. A touch-screen mounted on the instrument connects to an on-board computer that controls the instrument's operations.

Figure 2-1: Main features of the PELORIS: front view

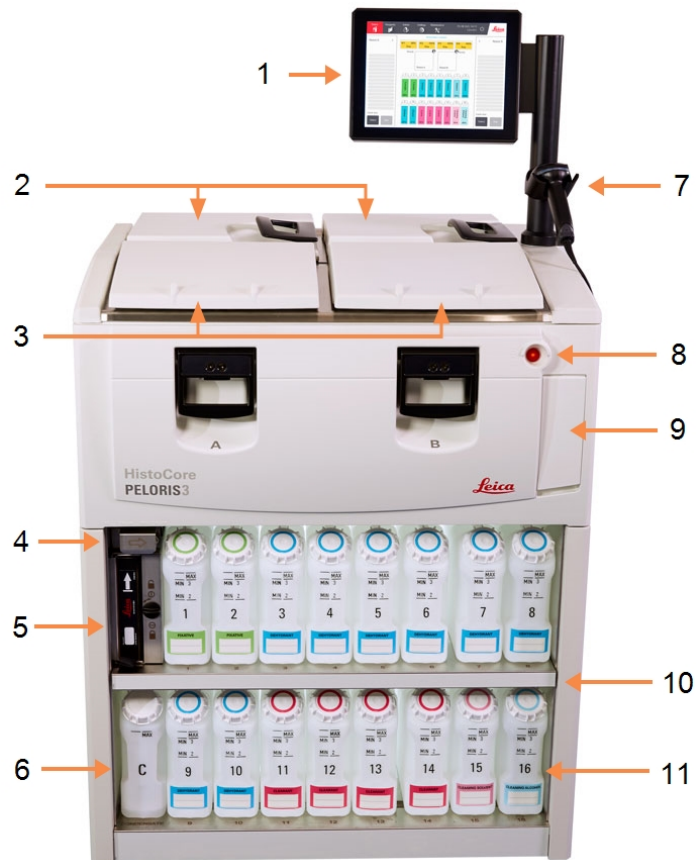

Legend

- 1 Touch-screen
- 2 Wax bath: with four wax chambers
- 3 Two retorts
- 4 Wax drain port, and reagent fill and drain port (behind flap)
- 5 Carbon filter
- 6 Condensate bottle

Legend

- 7 Scanner
- 8 Power button
- 9 USB port (beneath flap) for exporting reports
- 10 Reagent cabinet with back-lighting
- 11 Reagent bottles with solvent-resistant level markings

Figure 2-2: Main features of the PELORIS: back view

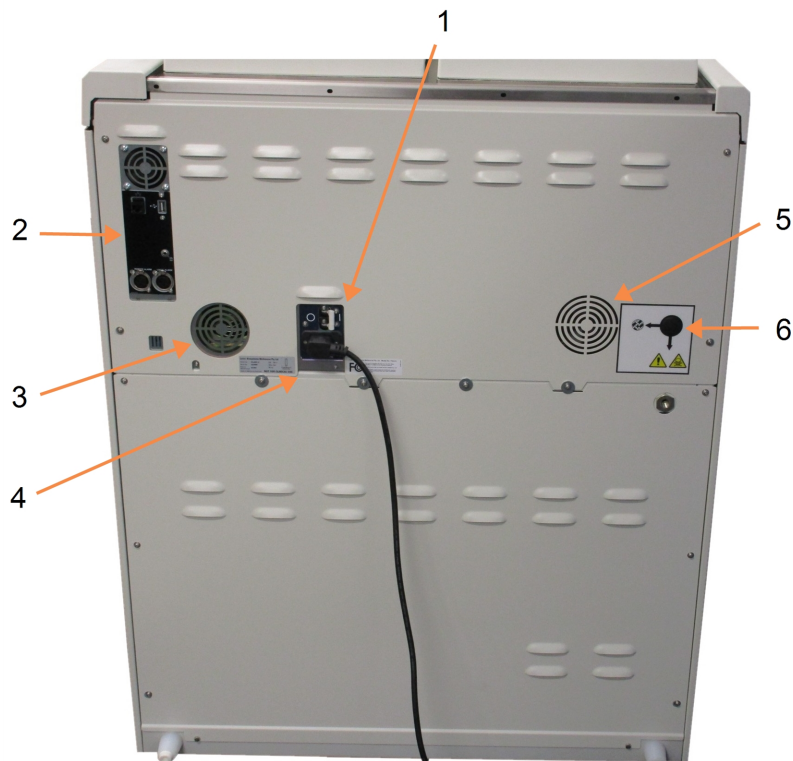

Legend

- 1 Circuit breaker
- 2 Communication Ports:
USB (for file transfers and
barcode scanner), Ethernet,
alarms
- 3 Fan
- 4 Power supply

Legend

- 5 Fan
- 6 Vapor outlet (for optional
external vapor control)

This chapter describes the main features of the PELORIS 3 hardware. There are sections on:

- [2.1 - Switching On and Shutting Down](#)
- [2.2 - Retorts](#)
- [2.3 - Wax Bath](#)
- [2.4 - Reagent Cabinet](#)
- [2.5 - Touch-screen](#)
- [2.6 - Scanner](#)
- [2.7 - USB Ports](#)
- [2.8 - External Vapor Removal Systems](#)
- [2.9 - Alarm Connections](#)

2.1 Switching On and Shutting Down

Under normal conditions, keep the PELORIS 3 on at all times, even when idle for extended periods. Shut it down for servicing or if moving the instrument.

Switching On

1. Ensure the mains power outlet socket is earthed.
2. Plug the power cable into the mains socket and switch on the power.
3. Move the circuit-breaker switch to the right to turn it on (see [Figure 2-2](#)).
4. Press the power button on the front of the instrument (see [Figure 2-1](#)).

Switching On after an Extended Shutdown

The technology used in the instrument heating elements is susceptible to moisture ingress while unpowered in unfavorable climatic conditions (high humidity) for an extended period. **If the instrument is left unpowered for more than three days**, then perform the following steps to ensure the instrument continues to meet the product standards.

Dry Out Procedure

1. Ensure the mains power outlet socket is earthed.
2. Plug the power cable into the earthed mains socket and switch on the power.
3. Move the circuit-breaker switch to the right to turn it on (see [Figure 2-2](#)).
4. Press the power button on the front of the instrument (see [Figure 2-1](#)).
5. Wait for 1 hour before any further interaction with the instrument.

The instrument is now ready for use.

Normal Shutdown

A normal shutdown shuts down the software in an orderly manner. The instrument must be idle, with no protocols or other operations in progress.

1. Either tap the shutdown button on the Function bar () or select **Settings > Instrument > Shutdown instrument**.
2. Wait for the touch-screen to go blank and then press the power button.
3. Move the circuit-breaker switch to the left to turn it off.
4. Switch the power off at the mains socket and pull out the power cable.

Emergency Shutdown

In an emergency, press the power button immediately.

If conditions permit, switch the power off at the mains socket and pull out the power cable.

2.2 Retorts

There are two retorts, each holding up to 300 tissue samples in three cassette baskets. Each retort operates independently, with its own temperature, pressure and stirrer-speed settings. The processor schedules resources so that both retorts can operate efficiently. The scheduling ensures that simultaneously running protocols do not use the same reagent bottle at the same time.

The subsections in this section are:

- [2.2.1 - Opening and Closing Retort Lids](#)
- [2.2.2 - Fill Levels](#)
- [2.2.3 - Magnetic Stirrer](#)
- [2.2.4 - Cassette Baskets](#)

2.2.1 Opening and Closing Retort Lids

Use the handles on the front of the instrument to latch and unlatch a retort lid.

Figure 2-3: Opening a retort lid



Always be aware of the contents, temperature and pressure of a retort before opening it. In some cases you may need to set the retort pressure and temperature manually before you can safely open it (see [2.2.1.1 - Venting a Retort](#)).

You may see a warning if the retort temperature is greater than either the retort empty access temperature (shown on the **Settings > Reagent Management** screen) or the safe access temperature associated with the reagent in the retort (set on the **Admin > Reagent Types > Temperature thresholds** screen).

The retort lids can be removed for cleaning (see [7.3.6.1 - Clean Lids and Seals](#)). Note that they are not interchangeable.



WARNING:

Retorts may contain very hot fluid that could cause severe burns. Wear suitable protective clothing and eyewear when opening a retort.



WARNING:

Retorts may contain hazardous reagents and vapors. When opening a retort, wear suitable protective clothing and eye-wear, and ensure that there is adequate ventilation.



WARNING: Take care not to knock retort lids when they are open. They could crush fingers or hands.

2.2.1.1 Venting a Retort

You must ensure that there is no pressure or vacuum inside a retort before you open the lid. The retorts automatically vent at the start and end of a protocol, and also during a pause in a protocol. However, you may need to manually vent a retort if an automatic vent fails or if you wish to access a pressurized or evacuated retort at other times.

Use the **Reagents > Manual Operations** screen to manually vent the retorts. Select the retort you want to open, tap the pressure button for that retort (it will have a label that ends with **Pressure**) and then tap **Ambient**. You may need to wait up to 90 seconds for the pressure to equalize.



Note: If you leave a hot retort closed for an extended time, the air in the retort will cool and create a vacuum. You must then vent the retort before opening the lid.

2.2.2 Fill Levels

Retorts can be filled with enough reagent for two or three cassette baskets. Supervisors set the required fill level on the **Settings > Instrument** screen (see [6.3.3.4 - Reagent Fill Levels](#)).

The two-basket fill volume is 3.8 liters (1 gallon US) and the three-basket fill volume is 5 liters (1.32 gallon US).

Markings on the reagent bottles ([Figure 2-4](#)) and in the wax chambers ([Figure 2-5](#)) will help you determine if you have enough reagent to fill the retorts to the required level. Always keep the reagent and wax volumes well above the markings, but below the maximum (MAX) level. Reagent levels below the minimum will cause protocols to either fail or use a sub-optimal reagent sequence.

Figure 2-4: Bottle fill levels

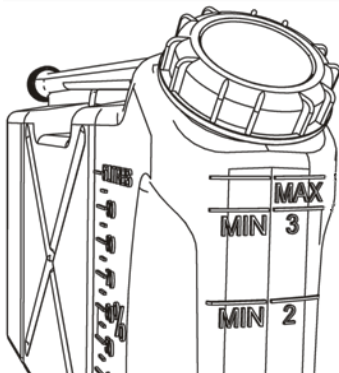
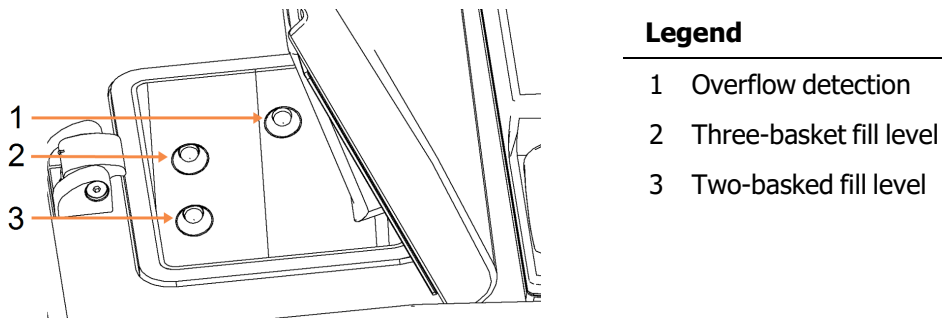

Figure 2-5: Wax chamber fill levels



2.2.2.1 Liquid Level Sensors (LLS)

Figure 2-6: Liquid level sensors



Each retort has three liquid level sensors to monitor fluid levels. The two lower sensors monitor the two- and three-basket levels. The top sensor is triggered if more than the maximum volume of fluid (5.3 liters) enter the retort. It serves a safety function.

The sensors may occasionally be affected by a build-up of condensation or deposited material. If this occurs, the software will direct you to wipe the appropriate sensor. Always ensure the sensors are kept clean as part of regular retort cleaning (see [7.3.6.2 - Clean Retorts and Liquid Level Sensors](#)).

2.2.3 Magnetic Stirrer

Each retort has as magnetic stirrer that stirs the reagent or wax to ensure a consistent temperature and good tissue penetration. The stirrer is driven by a magnetically-coupled external motor. The stirrer speed can be controlled for each protocol step and is easily removed for cleaning (see [7.3.6.2 - Clean Retorts and Liquid Level Sensors](#)).

Figure 2-7: Magnetic stirrer (1)

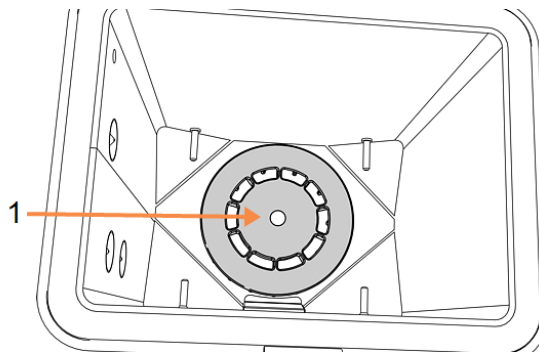

2.2.4 Cassette Baskets

There are two types of basket suitable for use with the PELORIS 3:

- the configurable high-capacity basket that accommodates the maximum number and type of cassettes (100) and
- the spaced basket that ensures optimal reagent flow.

The high-capacity cassette baskets accept most common cassette types and include configurable dividers that allow for different cassette sizes and packing densities.

The spaced baskets include dividers that ensure optimum reagent flow with minimal carryover. This basket type accepts 72 standard cassettes. Spaced baskets must be used for all xylene-free protocols.

Cassette baskets stack into the retorts with the lids upwards and handles dropped into the center recess so as to be flush with the top of the basket. Make sure the first basket sits flat on the basket support at the bottom of the retort ([Figure 2-9](#)). Stack additional baskets so they sit flat on the lower ones. Crooked baskets can leave cassettes exposed, damaging the tissue in them.

Figure 2-8: Placing a basket into a retort



Figure 2-9: Basket support

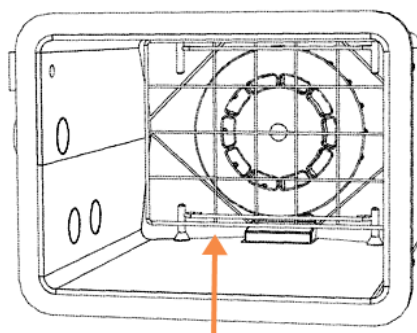

WARNING:

Always ensure the cassettes are correctly inserted into the baskets and that the baskets are correctly placed in the retorts. Incorrectly placed cassettes or baskets may lead to samples being damaged as some tissue may not be fully covered by reagent during processing.



WARNING:

Never place three baskets into a retort when the instrument is configured only to the two-basket fill level. If this occurs, reagent will not cover the top basket and tissue samples will be damaged.

2.2.4.1 Basket lid and handle

The lid fits firmly over the cage of the basket, with two lugs on the inside edges fitting into holes on the top of the cage. You can lift off the lid by firmly grabbing its sides and lifting upwards.

The handle is recessed along the central axis of the basket and can be extended by lifting it upward.

Figure 2-10: High-capacity cassette basket

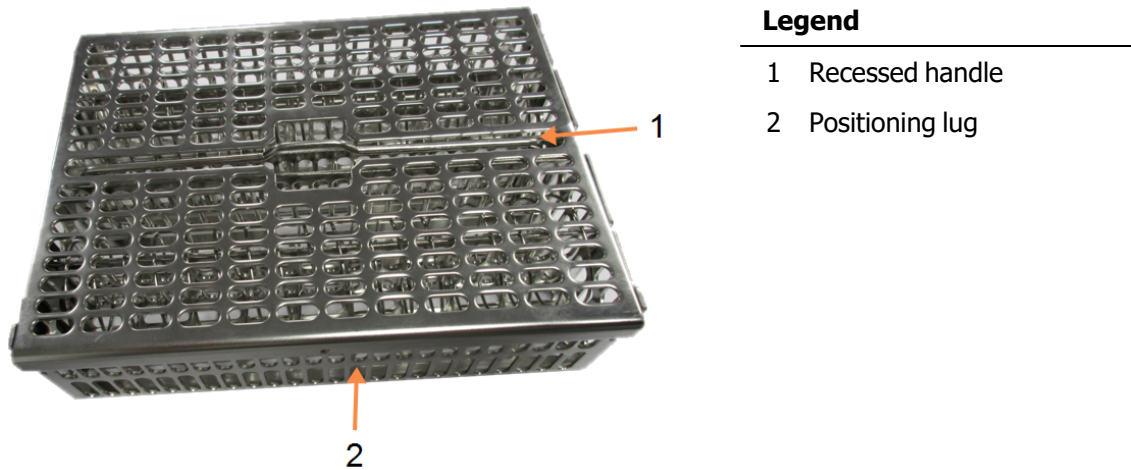

2.2.4.2 High-capacity Baskets

High-capacity baskets have dividers to configure the baskets to hold different numbers of cassettes. Use all the dividers to configure the baskets for orderly packing (up to 88 cassettes) or the long dividers only for tight packing (up to 100 cassettes).

For orderly packing, insert both the long and short dividers into the basket. This arrangement makes it easier to insert and remove the cassettes. Six standard cassettes can be placed in the end sections of each row and five in the middle sections, giving 88 cassettes per basket.

For tight packing, insert only the long dividers. This allows you to pack the maximum number of cassettes: 25 per row.

For large or unusually shaped cassettes use baskets with all the dividers removed.



CAUTION:

Do not use high-capacity baskets for xylene-free protocols as this may lead to wax build up that will eventually require service intervention.

2.2.4.3 Spaced Baskets

The spaced baskets include a fixed divider that ensures that the cassettes are correctly spaced for optimal processing. Each spaced basket can fit up to 72 standard cassettes. The cassettes are inserted between the spacing springs (shown in [Figure 2-11](#)).

Figure 2-11: Detail of cassettes packed into a spaced basket

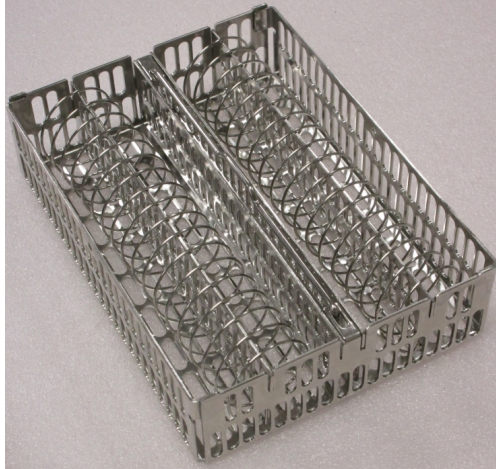

You must use spaced baskets when running xylene-free protocols.

2.2.4.4 Anti-reflection tags

For the liquid level sensors (LLS) to accurately detect the volume of liquid in a retort, anti-reflection tags must be fitted at diagonal corners of cassette baskets (see [Figure 2-12](#)). Two tags are provided with each basket.

Figure 2-12: Filled basket showing an anti-reflection tag (1)

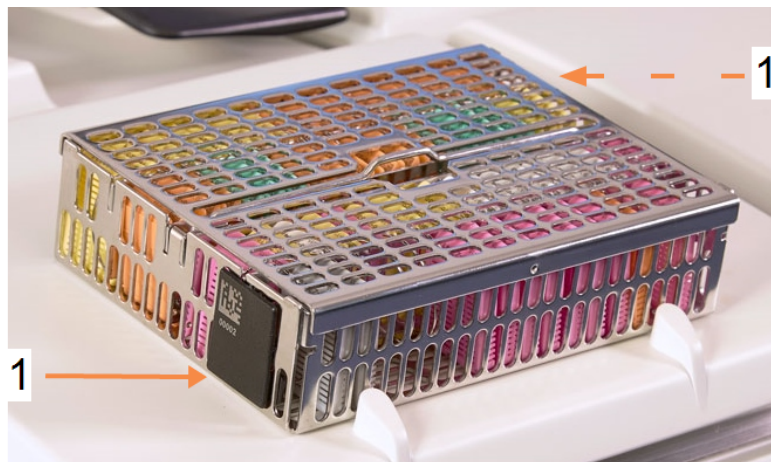

One anti-reflection tag per basket will have a unique barcode printed on it. This can be scanned before the basket is placed in the retort. The identifying code is recorded along with the other details of the processing run. After scanning the anti-reflection tag, you can place the basket in the retort in either orientation (that is, with the reflection tag with the barcode on it at the left or the right).

2.3 Wax Bath

The wax bath at the top rear of the instrument has four wax chambers accessed by two lids. Each chamber acts independently, holding enough wax to fill a retort. Although wax does not move between the chambers, they are connected for air flow and so always have the same pressure.

Use the lid handles to open the lids. Always use the handles to close the lids, ensuring the lids are properly latched. Be sure not to knock the lids when they are open as they may slam shut and crush fingers or hands.

Figure 2-13: Opening a wax bath lid



Always ensure that the wax bath pressure is at ambient pressure before opening the lids. If the pressure is not ambient, vent the bath first. You can do this when you pause a running protocol or from the **Reagents > Manual Operations** screen. (See [6.1.1 - Manual Operations](#).)

View the current temperature of each wax station by going to **Reagents > Stations > Wax chambers**.

Depending on the reagents you use, you can set the instrument to clean the wax in the bath (see [6.3.2.4 - Wax Bath Settings](#)).

Drain used wax with commands on the **Reagents > Remote fill/drain** screen. Directly fill the wax chambers with molten or solid wax (see [5.4.5 - Replacing Wax](#)).



WARNING: Take care when opening the wax bath after a xylene-free protocol, as the protocol will leave very hot wax in the bath.



WARNING: Never open a wax bath lid when there is wax in a retort or wax is being transferred. Hot wax may splash out of the bath.



WARNING: Take care not to knock wax bath lids when they are open. They could crush fingers or hands.

2.4 Reagent Cabinet

Figure 2-14: Reagent cabinet

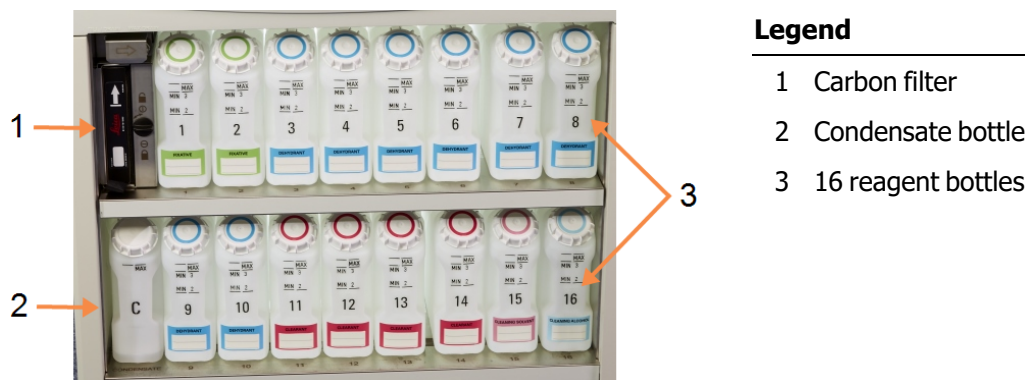

Legend

- 1 Carbon filter
- 2 Condensate bottle
- 3 16 reagent bottles

The reagent cabinet houses the reagent bottles, condensate bottle and carbon filter. It is back-lit and the bottles are translucent to help you to see the level of reagent in a bottle. See:

- [2.4.1 - Reagent Bottles](#)
- [2.4.2 - Condensate Bottle](#)
- [2.4.3 - Carbon Filter](#)

2.4.1 Reagent Bottles

The reagent cabinet holds sixteen reagent bottles. This is three more than standard tissue processors and it ensures that there are sufficient reagents to simultaneously schedule protocols in both retorts while also having ample cleaning reagents ready for use. The bottle at each station holds sufficient reagent to fill a single retort.

The bottles are translucent and have color-coded caps and labels. They also have markings on the front showing:

- the minimum level for a two-basket run
- the minimum level for a three-basket run and
- the maximum fill level.

To remove a bottle, pull the bottle out. Push back in position to return; you will feel the bottle fitting into its connection point on the back of the cabinet.

You can replace the reagent in a bottle either:

- manually, after having removed the bottle from the instrument, or
- semi-manually, with the bottle still in position in the reagent cabinet but being filled using commands on the **Reagents > Remote Fill/Drain** screen (see [5.4.1 - Remote Fill/Drain Screen](#)).



Note: Some chemicals may cause the bottles to expand over time. This is normal and does not affect the performance of the instrument.



WARNING: Never run the instrument with missing bottles or with loose or missing bottle lids, as fluid spills and vapor leaks will occur.

2.4.2 Condensate Bottle

A separate bottle collects condensate fluid. It sits beside the reagent bottles in the lower section of reagent cabinet. Empty the bottle weekly. Do not allow the bottle to overflow, as condensate fluid may contaminate other reagents.



WARNING: Never run the instrument with the condensate bottle missing or its lid either loose or missing, as fluid spills and vapor leaks will occur.

2.4.3 Carbon Filter

The carbon filter absorbs reagent fumes, thus preventing them from entering the laboratory atmosphere. To ensure that the filter operates effectively, it must be replaced periodically. Supervisors can set a replacement threshold by tapping **Carbon filter threshold** on the **Settings > Instrument** screen. The carbon filter can be bypassed by connecting the instrument to an external vapor removal system (see [2.8 - External Vapor Removal Systems](#)).



WARNING: Never run the instrument without the carbon filter or an external filter system, as this will release potentially dangerous fumes into the laboratory.

The filter must be installed with the arrow on the front pointing upwards and the locking mechanism closed (see [7.3.8.1 - Change Carbon Filter](#)).

2.5 Touch-screen

A touch-screen mounted on the right of the PELORIS 3 connects to a computer in the instrument that controls all instrument operations.

Use the touch-screen to configure the instrument, run protocols, and perform ancillary operations such as replacing reagents. Tap buttons and icons with your finger or a blunt object. Do not use sharp objects. Ensure no strong solvents come into contact with the touch-screen.

Optional stick-on/peel-off touch-screen protectors, provided by Leica Biosystems, can be used to protect the touch-screen.

In its normal operating position, the touch-screen sits over a wax bath lid, but it can be rotated to give easy access to the bath.



CAUTION: If the touch-screen goes blank or is unreadable, turn off the instrument immediately.

2.6 Scanner

There are two types of scanner available for PELORIS 3:

- [Barcode Scanner](#)
- [HistoCore I-Scan](#)

2.6.1 Barcode Scanner

The barcode scanner sits in a cradle mounted on the post that supports the touch-screen (see [Figure 2-15](#)).

Figure 2-15: Barcode scanner in its cradle



The scanner can be used to quickly enter your user ID, the ID on a basket's anti-reflection tag (see [2.2.4.4 - Anti-reflection tags](#)), or the lot or batch number of a reagent. It can scan the following barcode formats:

- Code 128 (1D)
- Code 39 (1D)
- Data Matrix (2D)
- QR (2D)

There are some restrictions with the characters used in barcodes. Use only alphanumeric characters (upper-case letters, A to Z; lower-case letters, a to z and numbers, 0 to 9). Avoid use of non-Latin characters as these may not be recognized by the instrument.

2.6.2 HistoCore I-Scan

The PELORIS 3 instrument may be equipped with a HistoCore I-Scan Optical Scanner. The HistoCore I-Scan must be enabled for use by a Supervisor access level or above in [6.3.4 - Device Settings](#). The HistoCore I-Scan sits in a cradle mounted on the post that supports the touch-screen.

Figure 2-16: HistoCore I-Scan



The HistoCore I-Scan provides 3 main functions, a barcode scanner, a built-in camera and an LCD screen that displays the images captured by the camera. The scanner can be used for performing the same functions as a conventional barcode scanner and the built-in camera is used for capturing images of the baskets filled with cassettes.

The HistoCore I-Scan has 3 buttons on the device for performing the operations.

Figure 2-17: HistoCore I-Scan buttons



Legend



- 1 **Fill-in LED button:**
Turns on/off the fill-in LED when in Camera Mode.
- 2 **Scanner/Camera button:**
Takes scan or image depending on which mode is active. The PELORIS software controls which mode is active.
- 3 **Send (Tick) button:**
Sends an event to the software in the PELORIS 3 instrument.
Note: This button is not activated on this tissue processor model.

2.6.2.1 Scanner Mode

In barcode scanner mode, an optical beam is pointed on the intended barcode and a bar rolls up and down the LCD screen. The optical beam disappears either after the barcode has been scanned or if the scanner is not used for more than 10 seconds.

Scan a barcode

1. Press the **Scanner/Camera button**

The scanner displays a tick  if the scan was captured successfully, or an exclamation mark  if the scan was not captured successfully .

2. If the scan was not captured successfully, press the **Scanner/Camera button** to try again.

The recommended distances for scanning barcodes are:

Barcode Format	Distance
EAN-13	50-200mm (13mil)
Code39	40-90mm (5mil 10 Byte)
QR Code	25-240mm (20mil 16 Byte)
Data Matrix	50-90mm (10mil 20 Byte)
PDF 417	30-130mm (6.67mil 7 Byte)



2.6.2.2 Camera Mode

In Camera mode, a preview of the target object is displayed on the LCD screen and you can also view the image on the LCD screen once it is captured by the camera.

Capture an image

1. Press the **Scanner/Camera button**

The camera takes about 2 seconds to auto focus on the target and capture the image.

The scanner displays a tick  if the image was captured successfully, or an exclamation mark  if the image was not captured successfully .

2. If the image was not captured successfully, press the **Scanner/Camera button** to try again.

2.6.2.3 Sleep and Wake Up

The HistoCore I-Scan goes into sleep mode and the LCD display powers off if there are no operations performed with the device for 5 minutes or when a user enters a full image viewer on the PELORIS instrument. The HistoCore I-Scan wakes up again and the LCD displays powers on once a user action is performed in the basket screen (see [3.1 - Quick Start](#)).

2.6.2.4 General precautions

- Handle the HistoCore I-Scan with utmost care.
- Do not open the shell of the device for any reason.

- Avoid scraping the LCD screen, the barcode engine and the camera.
- Always keep the device in its holder when not in use to prevent it falling from the instrument.
- Wipe off any traces of water or liquids immediately from the LCD screen.
- Before cleaning, unplug the device from power supply and clean only using soft cloths. The recommended cleaning agents are water with mild soap or alcohol wipes.
- Avoid liquid from getting into the body of the device to prevent malfunctioning of the HistoCore I-Scan.
- If there is any leakage of liquid crystal-like materials from the LCD panel, please keep away from eyes or mouth. In case of contact with either skin or clothing, the recommendation is to immediately wash the area thoroughly with soap.
- Do not leave the HistoCore I-Scan in an area with high temperature or high humidity for long durations.
- Do not leave the HistoCore I-Scan exposed to direct sunlight.

2.7 USB Ports

There are two USB ports on the PELORIS 3, one on the rear panel ([Figure 2-18](#)) and one on the front beneath a flap ([Figure 2-19](#)).

Figure 2-18: USB on rear panel



Figure 2-19: Front USB port, behind flap



The USB ports can be used to:

- connect the barcode scanner: the rear USB port is best for this (and this will be the default hardware configuration)
- export logs and incident reports: the front USB port is best for this
- export and import protocol files: the front USB port is best for this.

Note that there is an Ethernet port beside the USB port on the rear panel. This can be used to link the instrument to your network.

2.8 External Vapor Removal Systems

The outlet for instrument vapors can be switched between the internal carbon filter and an external vapor extraction system. On the rear panel is a valve that directs vapors to either the carbon filter or to an outlet that can be connected into the external system.

- For instructions on changing to an external vapor system, see [2.8.1 - Connecting to an External System](#) below.
- For instructions on returning to the internal carbon filter system, see [2.8.2 - Returning to the Internal Filter System](#).

Figure 2-20: Vapor select valve (1) and vapor outlet (2)

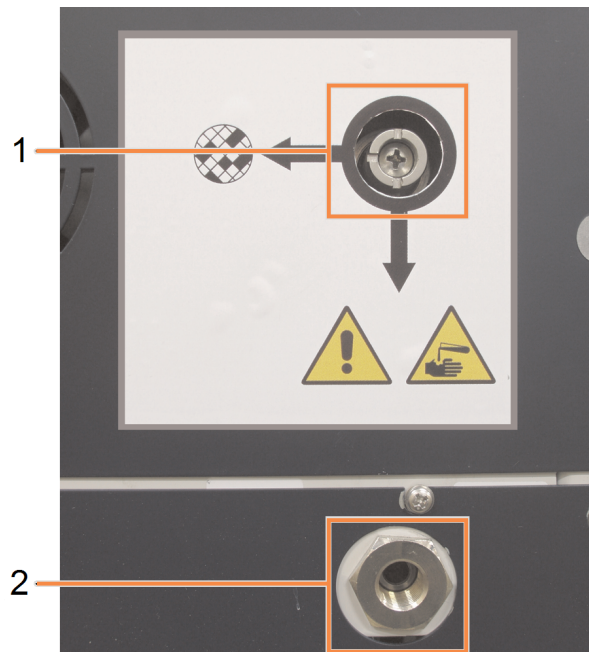

2.8.1 Connecting to an External System



WARNING: When the vapor select valve is in the external position, you must ensure an external vapor system is correctly installed; otherwise potentially dangerous fumes will be released into the laboratory environment.

To connect the instrument to an external vapor system:

1. Connect the instrument's vapor outlet (see item 2 in [Figure 2-20](#)) to the external system.
2. Turn the vapor select valve a quarter turn counterclockwise. This will direct vapors to the vapor outlet (see [Figure 2-21](#)).

Note: to access the valve you may need to remove a blanking plug.

Figure 2-21: Vapor select valve in the external system position

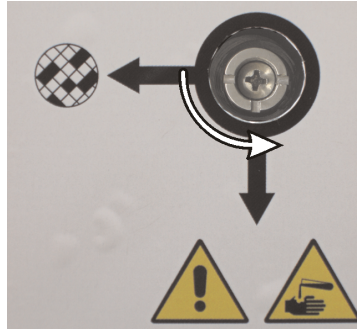

3. Set the carbon filter threshold to one of the following options:
 - i. The inspection interval for the external system (see [6.3.3 - Instrument Settings](#)).
 - ii. The maximum value (1000) to limit the number of unwanted warnings (see [6.3.3 - Instrument Settings](#)).
 - iii. Overridden (contact your service representative to arrange this setting).

2.8.2 Returning to the Internal Filter System



WARNING: When the vapor select valve is in the internal position, you must ensure the carbon filter is correctly installed; otherwise potentially dangerous fumes will be released into the laboratory environment.

To resume using the internal carbon filter:

1. Ensure that a new carbon filter is correctly installed (see [2.4.3 - Carbon Filter](#)).
2. Turn the vapor select valve a quarter turn clockwise. This will direct vapors to the carbon filter (see [Figure 2-22](#)).

Note: to access the valve you may need to remove a blanking plug.

Figure 2-22: Vapor select valve in the internal filter position

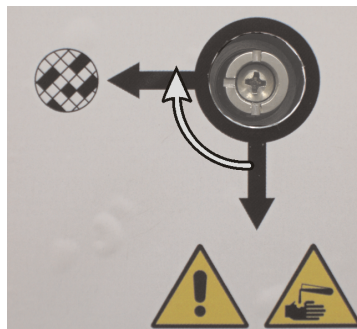

3. If required, disconnect the external system from the vapor outlet (see item 2 in [Figure 2-20](#)). You can leave the external system connected as the vapor valve effectively isolates this outlet.
4. Set the carbon filter threshold to a value appropriate for your instrument's workload. We recommend an initial threshold of 60 days, with adjustments only if you are sure the carbon filter is becoming saturated earlier or is still in good condition after this time (see [6.3.3 - Instrument Settings](#)).



Note: If the carbon filter threshold has been overridden, the carbon filter buttons will not be available. Arrange for your service representative to cancel the override.

2.9 Alarm Connections

Each PELORIS 3 has two external alarm connections: a remote alarm connection and a local alarm connection (see [Figure 2-23](#)). The alarm connections are situated on the back of the instrument. These connections can be used to control a range of alarm indication devices, including audible alarms, visual alarms or automatic phone dialers.

Figure 2-23: Remote alarm (1) and local alarm (2) connectors

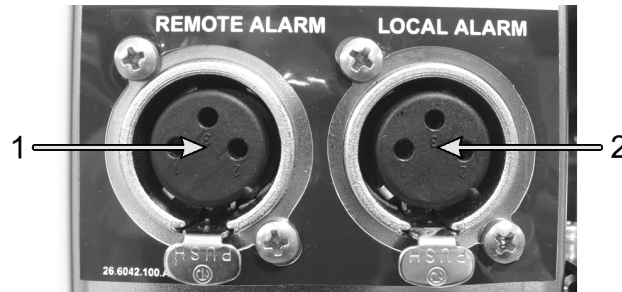

Speak to your service representative to configure the events that will trigger each of the external alarms, and to set whether the alarms are a single signal (that is, momentary) or continuous (repetitive).

2.9.1 Alarm Connector Specifications

The load connected to either alarm connector must not exceed the following specifications.

- Maximum voltage: 30 V DC
- Maximum current: 1 A (resistive load)
- Maximum current: 0.5 A (inductive load)

2.9.2 Alarm Connector Pins

Each alarm connector has three pins as follows (see [Figure 2-24](#)):

Figure 2-24: Alarm connector pins

- Pin 1 — Normally open (item 1)
- Pin 2 — Normally closed (item 2)
- Pin 3 — Common (item 3)

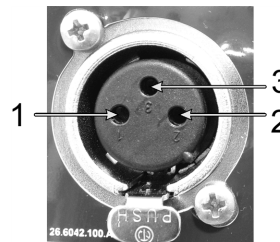

2.9.3 Pin Schematic During Normal Operation

When the instrument is operating normally (no alarm) the alarm pins connect as shown in [Figure 2-25](#).

Figure 2-25: Alarm pins in normal state

- Pin 1 — Normally open (as shown)
- Pin 2 — Normally closed and connected to Pin 3 — (as shown).

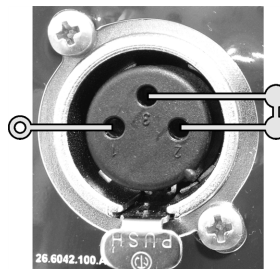

2.9.4 Pin Schematic During Alarm Conditions

When the instrument has an active alarm, the alarm pins connect as shown in [Figure 2-26](#) below.

Figure 2-26: Alarm pins in alarm state

- Pin 1 — Normally open and connected to Pin 3 (as shown).
- Pin 2 — Normally closed but open during alarm conditions (as shown).

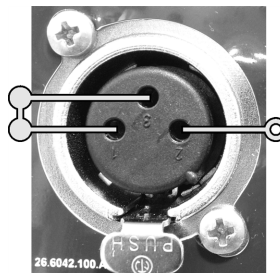

2.10 Instrument Decommissioning and Disposal

The instrument, including parts and associated accessories used, must be disposed of according to applicable local procedures and regulations. Dispose of any reagents used with the instrument in accordance with the recommendations of the reagent manufacturer.

Clean and decontaminate in accordance with local procedures and regulations before returning or disposing of the instrument or parts and accessories.

In the EU, all electronic waste must be disposed of in accordance with Waste Electrical and Electronic Equipment (2012/19/EU). In regions outside of the EU, follow local procedures and regulations for the disposal of electronic waste.

If you need assistance, contact your local Leica Biosystems representative.

3. Running Protocols

This chapter describes how to run protocols on the PELORIS 3. The instrument must have reagents and protocols set up before protocols can be run. Further, protocols must be validated before operators can run them. See [Chapter 4 - Protocol Setup](#) and [Chapter 5 - Reagent Setup](#) for more information.

This chapter has the following sections:

- [3.1 - Quick Start](#) – covers preprocessing checks, loading and running protocols, and protocol completion.
- [3.2 - Cleaning Protocols](#)
- [3.3 - Status Screen](#) – covers the loading and monitoring of both protocols and reagents.
- [3.4 - Protocol Run Options](#) – covers scheduling protocols for immediate or delayed start, and how to edit the steps and step times for a single protocol run.
- [3.5 - Pausing and Abandoning Protocols](#) – covers pausing a protocol run to safely access a retort, abandoning a run, and emergency stopping procedures.
- [3.6 - Retort Scheduling](#) – provides information to help you maximize the efficiency and flexibility of your PELORIS 3.

3.1 Quick Start

Before you begin, all the reagents you need must be configured. Further, for users with operator-level access only, there must be at least one validated protocol ready to load. See [5.3 - Managing Reagent Stations](#) and [4.2 - Creating, Editing and Viewing Protocols](#) for information about these topics.

Instrument Checks and Setup

1. Tap the **Status** button to display the **Status** screen.
All protocol runs begin from the **Status** screen. See [Figure 3-3](#).
2. Check that the icon of the retort you want to use shows that the retort is either clean or has residue of a reagent compatible with the first reagent of the protocol. See [Table 3-1](#).
3. If necessary, replace any reagent, or the wax in a wax chamber, that needs to be replaced (see [5.4 - Replacing Reagents](#)). The standard icons for reagents and wax chambers will have been modified in various ways if replacement is needed or recommended. See [3.3.1.1 - Bottle Icons](#) and [3.3.1.2 - Wax Chamber Icons](#).
4. Check that the instrument is ready:
 - i. All 16 bottles must be properly installed on the instrument.
 - ii. There must be enough reagent in the bottles and wax chambers.

Fill the bottles and chambers to at least the MIN 2 level if you fill retorts to the two-basket level, or to at least the MIN 3 level if you fill retorts to the three-basket level. (You can see the settings for the reagent fill levels by going to **Settings > Instrument**.)
 - iii. Open the retort to use. Check that it is clean, or that any residue is a reagent compatible with the first reagent in the protocol.
 - iv. If applicable, check the HistoCore I-Scan settings by going to **Settings > Device** (See [6.3.4 - Device Settings](#)).
5. Prepare your cassettes and load them into baskets (see [2.2.4 - Cassette Baskets](#)).
6. Tap on the icon of the retort you want to use.
The **Retort [...] Baskets** screen appears. This screen will look different depending on which scanner is in use.

If you are using the barcode scanner, the following screen is displayed:

If you are using the HistoCore I-Scan optical scanner, the following screen is displayed:

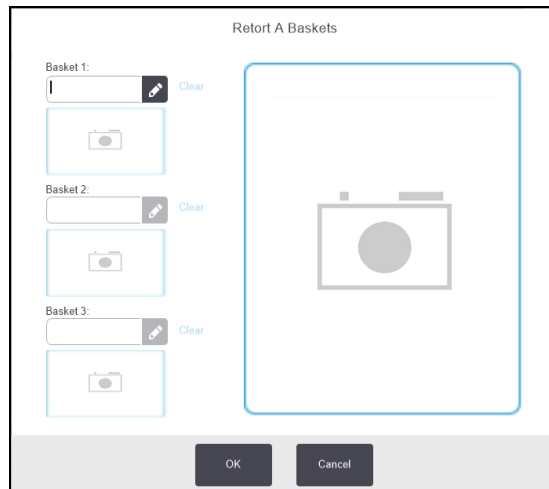

7. Optionally scan the baskets.

If you are using the barcode scanner, you need to scan the basket ID only.

If you are using the HistoCore I-Scan optical scanner, you need to scan the basket ID and also capture an image of the corresponding basket. The **OK** button is disabled until both are captured.



Note: Each basket has a 2-D barcode on one of its anti-reflection tags. Scanning the barcode (or entering it by hand), and capturing the basket image is an optional step but doing so will help you track tissue specimens as they progress through the laboratory.

8. When you are finished, tap **OK**.

9. Place the baskets into the required retort and firmly close the retort lid. If the baskets were scanned, the number scanned will appear beside the retort's icon on the screen (see [Table 3-1](#)). Great

Load Protocol

1. Tap the **Select** button at the bottom left (for retort A) or bottom right (for retort B).

The **Protocol Selection** screen opens.

2. Tap once on the protocol you want and tap **Load**.

Only validated protocols (indicated by a green tick) can be selected by operator-level users.



Legend

- 1 Validated protocol
- 2 Unvalidated protocol

See [4.1.4 - Protocol Validation](#) for more information.

The **Status** screen reopens with the protocol loaded.

3. Running Protocols

3. If you want to add a note to the protocol, tap Add note (📎 Add note). Using the on-screen keyboard, type your note and tap **Enter**.

Notes can also be added to a protocol while the protocol is running.

Run Protocol

1. Tap the **Run** button. (This button becomes enabled only when a protocol has been loaded in the corresponding retort)
2. If the first step of the protocol uses a reagent that is incompatible with retort residue, a warning message is displayed. You may need to run a cleaning protocol or you may be able to skip the first steps of the protocol (see [3.4.2 - Changing the Starting Step for a Single Run](#)). If so, tap **Continue** in the warning dialog box.

A dialog box appears for you to enter the number of cassettes that are in the retort.

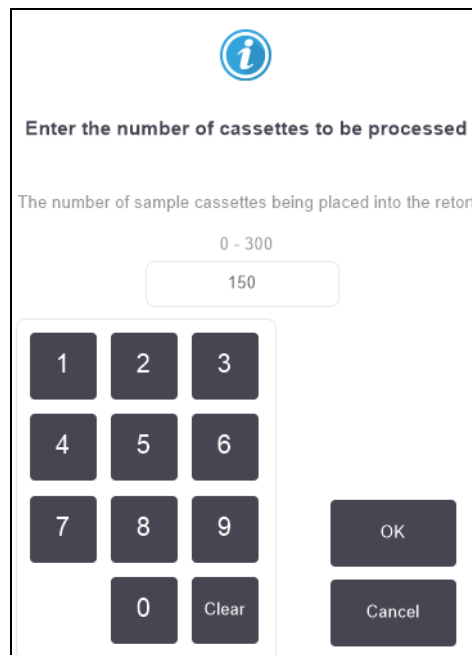

The screenshot shows a dialog box with a blue information icon at the top. The title is "Enter the number of cassettes to be processed". Below the title is a subtitle: "The number of sample cassettes being placed into the retort". A range "0 - 300" is displayed above a text input field containing the number "150". Below the input field is a numeric keypad with buttons for digits 1-9, 0, and a "Clear" button. To the right of the keypad are two buttons: "OK" and "Cancel".



Note: The number displayed by default is set by supervisors. (See [6.3.2 - Reagent Management](#).) However, it is important that you enter the correct number of cassettes. The figure you enter is used by the reagent management system to calculate reagent concentrations.

3. Enter the number of cassettes and tap **OK**. The scheduling screen appears.

Figure 3-1: Scheduling Screen

4. If you want to edit any steps in the protocol, or change the duration of a step, tap **Edit steps**. The process is explained in [3.4.2 - Changing the Starting Step for a Single Run](#).
5. If you want to run the protocol immediately, tap **ASAP** and continue with [step 7](#) below.
6. If you want to delay the start of the run:
 - by a full day, tap **+Day**
 - by any other time, tap **Edit end time** and specify a delay. (The process is explained in detail in [3.4.1 - Scheduling Protocols](#).)
7. Check that the predicted end time shown on the screen is acceptable. If it is not, repeat from [step 5](#) above.
8. Enter your user name. You can do this either by:
 - scanning your ID or
 - tapping the edit icon () and typing your user name with the on-screen keyboard.



Note: User name is a unique identifier for each user. The user name entered here must match the user name created for you. Contact your Supervisor if you don't know or forgot your user name.

9. The **Start** button will now be enabled. When you tap it, the system schedules the protocol.
 - If the system is unable to schedule the protocol, warning messages will appear. Tap **OK** and correct all errors before attempting to run the protocol again (see [3.6.2 - Unavoidable Reagent Clashes](#) for a description of possible scheduling difficulties).
 - If the system was able to schedule the run, the protocol will begin.
 - If you have set a delayed end time, an initial fill condition will occur (see [3.6.1 - Delayed End Times and Initial Fills](#)).

You can view the progress of the run on the **Status** screen.

You can pause the protocol run to add additional cassettes, or abandon the run completely (see [3.5 - Pausing and Abandoning Protocols](#)).

Finish Protocol Run

1. When the protocol is finished the **Protocol complete** dialog box appears and an alarm sounds.

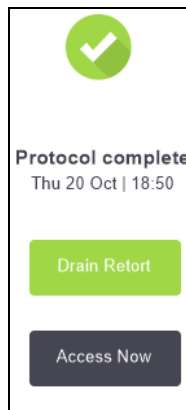

You can remove the baskets before draining the retort, although this option is not recommended.

To drain the retort, tap **Drain Retort**; otherwise tap **Access Now**.

2. When prompted to, open the retort.
3. A message appears prompting you to remove all tissues. Do so and tap **Done**.

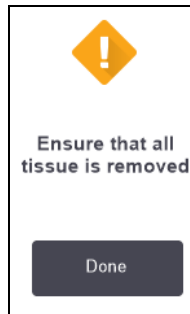

Figure 3-2: Do not tap **Done** until all baskets have been removed from the retort.

Run Cleaning Protocol

The **Clean now** panel is now displayed. You should always run a cleaning protocol as soon as possible after a tissue-processing run.



WARNING: Remove all tissue from the retort before running a cleaning protocol, as the dry step will damage the tissue.

1. If you want to accept the preselected default protocol for cleaning, tap **Start** and continue from [step 6](#) below. Otherwise, tap **Select**, select the cleaning protocol and run it just as you would a tissue-processing protocol (as described in this procedure).
2. You are prompted to place your dirty baskets in the retort. Make sure that all tissue has been removed from the baskets before you do so.
Tap **Done** when you have placed the baskets in the retort and closed the lid of the retort.
3. If you want to edit the steps in the cleaning protocol, tap **Edit steps**. The process is explained in [3.4.2 - Changing the Starting Step for a Single Run](#).

-
4. Enter your user name. You can do this either by:
 - scanning your ID or
 - tapping the edit icon () and typing your user name with the on-screen keyboard.



Note: User name is a unique identifier for each user. The user name entered here must match the user name created for you. Contact your Supervisor if you don't know or forgot your user name.

5. Tap **Start** to begin the run.
6. When the protocol is finished the **Protocol complete** panel appears and an alarm sounds. Tap **Access Now** to continue.
7. When the **Access retort now** panel appears, open the retort lid and remove the baskets.
8. Tap **Open Retort** to continue.



WARNING: Do not open a retort while a protocol is running as the retort could be pressurized and may contain hot reagent and fumes. Always follow the retort access instructions detailed in [3.5 - Pausing and Abandoning Protocols](#) if you need to access a retort during processing.

3.2 Cleaning Protocols

Cleaning protocols clean the retorts and reagent lines. Always run a cleaning protocol as soon as possible after a processing run. You can select the **Clean now** option when prompted at the end of a run. This runs the pre-defined cleaning protocol (called **Quick Clean**). Alternatively, you can choose another cleaning protocol.

You should also clean retorts:

- after replacing reagent using the remote-fill-and-drain functionality
- if you filled them manually, or
- if the last reagent is not compatible with the next protocol to be run. (See [8.5 - Reagent Compatibility Tables](#).)

For most laboratories, the pre-defined **Quick Clean** protocol should be the only cleaning protocol required. Under normal conditions, the protocol purges residue in the retort to the wax bath before the first step (see [3.2.3 - Pre-cleaning Purges](#) below). Then there are two reagent steps: cleaning solvent (e.g. xylene) and cleaning alcohol. These are followed by a dry step. This step applies high temperature, vacuum and air flow to evaporate any reagent residue. At the end of the dry step the heaters turn off but air flow continues to cool the retorts before the next protocol.

Load and run cleaning protocols as you would other protocols, but never with tissue in the retort. The dry step will damage it. This means that cleaning protocols should never be used for reprocessing runs. Use a reprocessing protocol instead.

If required, copy the **Quick Clean** protocol and edit it to create your own cleaning protocols. You can add, delete and edit all reagent steps with the exception of the dry step. Cleaning protocols do not require a water step and work well with conventional cleaning reagents.

To completely remove xylene from your instrument, Leica Biosystems can supply Waxsol™, a xylene-free cleaning solution (see [5.1.4 - Recommended Reagents](#)).



WARNING: Remove all tissue from the retort before running a cleaning protocol, as the dry step will damage the tissue.



WARNING: Do not use cleaning protocols for reprocessing, as the dry step will damage the tissue.



CAUTION: Always run a cleaning protocol after wax has been in the retort.



CAUTION: Do not reuse contaminated dehydrants as cleaning alcohol. The contaminated dehydrants will contain formalin (or other fixatives) and the dry step will cause salts to crystallize on the retort's internal surfaces.

3.2.1 Cleaning Laboratory Implements

You can clean metal laboratory implements—such as cassette lids and metal molds—during cleaning runs, but it is important to set reagent purity thresholds that take this into account.

All the pre-defined cleaning reagents have *cycle* purity thresholds. These thresholds force reagents to be replaced after ten or six cleaning runs (if they do not exceed a concentration threshold first). But the thresholds are designed for cleaning runs with only cassette baskets in the retorts. Any additional material increases the rate at which the cleaning reagents degenerate, thereby requiring lower cycle thresholds. If you clean implements other than baskets, lower the cycle thresholds for the reagents used so that the reagents are replaced more frequently (see [5.2.2 - Editing Active Reagent Types](#)). Depending on the number of implements you typically place in the retorts, you may need to reduce the thresholds by half or more. Contact your technical support representative for advice if required.

**CAUTION:**

If you clean laboratory utensils, metal cassette lids, metal molds etc. in cleaning runs, lower the cycle purity thresholds for the cleaning reagents used. Failure to do so can lead to overly contaminated cleaning reagents and lower quality cleaning.

3.2.2 Modifying Cleaning Protocols for Different Retort Residues

Always run a complete cleaning protocol as soon as possible if wax or clearing reagent are left in the retorts.

For alcohol or formalin residue, skip the first step of the protocol and start at the alcohol step (see [3.4.2 - Changing the Starting Step for a Single Run](#)).

A residue of clean formalin can be allowed to stay in a retort if the next processing protocol begins with a formalin step. If you are left with formalin in a retort at the end of a protocol, you can continue without cleaning if required. When the **Clean now** panel appears, the default cleaning protocol is preloaded, ready to run. To bypass this cleaning protocol:

1. Tap **Select**.
2. Tap any tissue-processing protocol.
3. Tap **Load**.
4. Tap **Unload protocol**.
5. Proceed with the next action of choice.

3.2.3 Pre-cleaning Purges

Cleaning protocols are generally run to clean wax residue from the retorts, as wax is the final step of processing protocols. To help maximize the useful life of the cleaning solvent, the instrument usually purges any wax residue from the retort to the wax chamber it came from before the cleaning protocol begins.

If you attempt to load a processing protocol to a retort with incompatible residue in it, you are warned with event 10011: "Incompatible reagent in retort. Clean retort or edit protocol." A cleaning protocol run after this warning will not have the normal purge to the wax chamber. This is in case fresh cassettes were placed in the retort, contaminating the wax residue with formalin. A purge under these conditions would contaminate the wax chamber with formalin.

If you ever place fresh cassettes into a dirty retort in preparation for processing, remove the cassettes and then attempt to load a processing protocol before loading the cleaning protocol. The 10011 warning raised when you attempt to load the processing protocol causes the cleaning protocol to skip the wax bath purge. The retort residue, now with formalin in it, will not go into the wax bath but into the cleaning solvent.

After the cleaning protocol finishes, replace the cleaning solvent (as it will now be contaminated with formalin).

In general, avoid this situation by always cleaning the retort immediately after a processing run. You will be prompted to do so. Do not put fresh cassettes into a retort that is showing residue in it, as indicated by the icon at right. (Formalin residue may be acceptable).

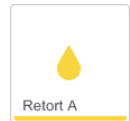

WARNING:

Do not load unprocessed tissue samples into a retort prior to running a cleaning protocol. Formalin in the residue purged to the wax bath at the start of the cleaning run may damage tissue on subsequent runs.

If you inadvertently load unprocessed samples into a retort prior to running a cleaning protocol, remove the samples and attempt to load a processing protocol before loading the cleaning protocol. The purge before the cleaning run will be skipped.

3.3 Status Screen

The **Status** screen is where you load and run protocols, and monitor a protocol's progress. The main features of the screen are shown in [Figure 3-3](#).

Figure 3-3: **Status** screen

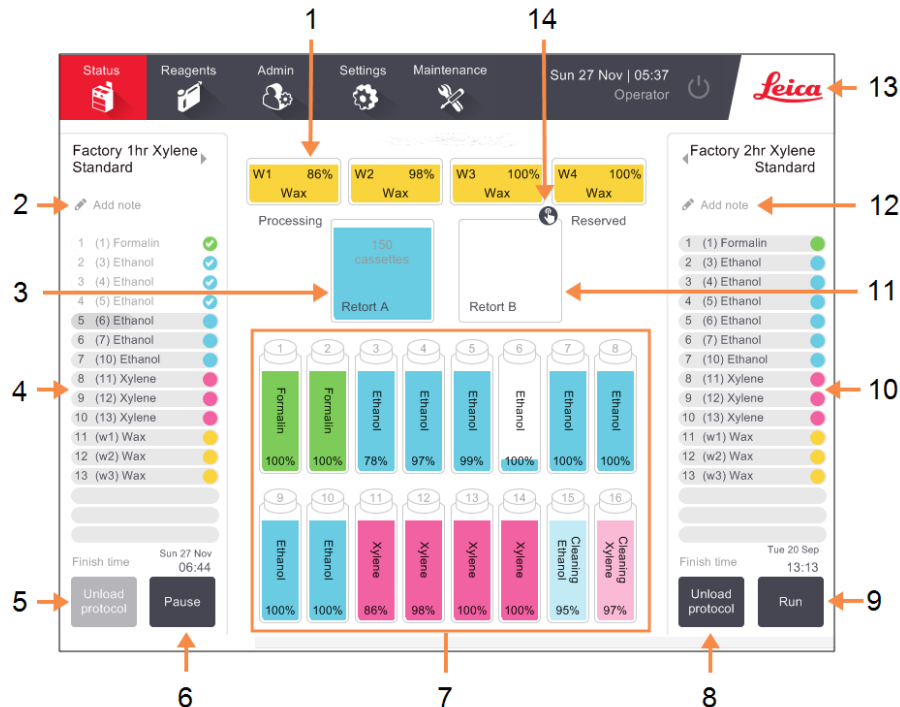

Legend

- 1 4 wax chambers: W1-W4
- 2 **Add Notes** button: protocol A
- 3 Retort A
- 4 Retort A protocol panel
- 5 **Select / Unload protocol:**
Button to load and unload protocols for retort A.
- 6 **Run / Pause** button for retort A
- 7 16 reagent bottles

Legend

- 8 **Select / Unload protocol:**
Button to load and unload protocols for retort B.
- 9 **Run / Pause** button for retort B.
- 10 Retort B protocol panel
- 11 Retort B
- 12 **Add Notes** button: protocol B
- 13 Leica icon and online help button
- 14 Basket ID icon

The central area of the screen shows the status of the stations and retorts. Panels at either side of the screen show the protocols loaded for the retorts. See:

- [3.3.1 - Status Area](#)
- [3.3.2 - Protocol Panels](#)

3.3.1 Status Area

The status area provides a visual guide to the status of the bottles, wax chambers and retorts (see [Figure 3-4](#)).

3.3.1.1 Bottle Icons

Figure 3-4: Bottle icons on the **Status** screen

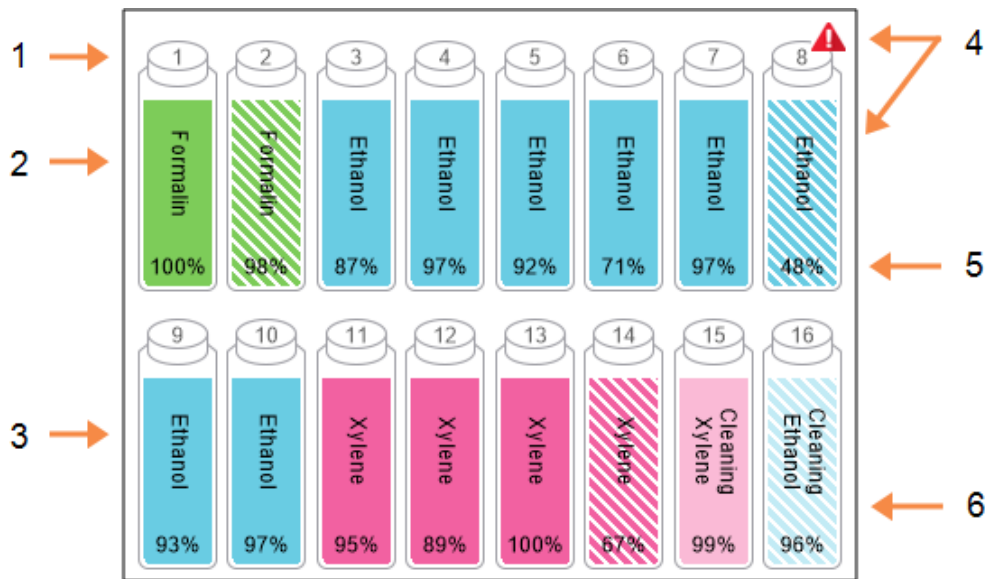







Legend

- 1 Bottle number
- 2 Reagent type
- 3 Color-coded by reagent group. Refer to [5.1.1 - Reagent Groups, Types and Stations](#) for color codes.

Legend

- 4 Warning symbol and cross-hatching shows reagent is out of threshold.
- 5 Reagent concentration (may not be visible, refer to [6.3.2 - Reagent Management](#)).
- 6 Color or other pattern shows station state (see below).

Bottles have six possible station states:

	Full	In use	Empty	Dry	No bottle	Unknown
Meaning	The bottle holds sufficient reagent to fill a retort at the specified basket level.	A reagent transfer is in progress or was abandoned. The reagent level is between full and empty.	The bottle has been used to fill a retort. There is still reagent in the bottle.	The bottle has been completely drained leaving only a small amount of residue.	The bottle has been removed.	A previously missing bottle has been replaced. You must enter the reagent and state details before using this station.
Icon						

3.3.1.2 Wax Chamber Icons

Figure 3-5: Wax chamber icons on the **Status** screen

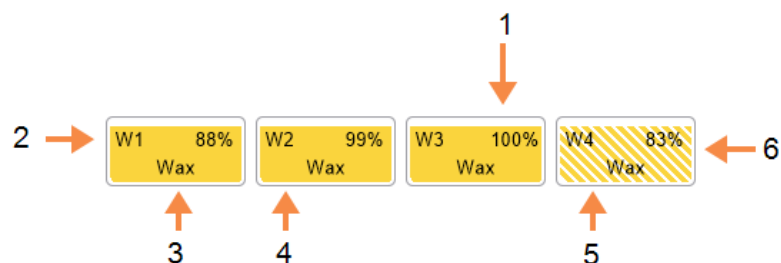





Legend

- 1 Wax concentration (may not be visible, refer to [6.3.2 - Reagent Management](#)).
- 2 Wax chamber number
- 3 Reagent type (i.e. type of wax)

Legend

- 4 Color-code: orange for reagent group "Wax".
- 5 Color or other pattern shows station state (see below).
- 6 Cross-hatching shows wax is out of change threshold.

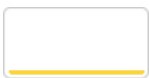
Wax chambers have four possible station states:

	Means	Icon
Full	The chamber has enough wax to fill a retort to the specified basket level.	
Part Full / In Use	A wax transfer is in progress or has been abandoned. The wax level is between full and empty.	
Empty	The chamber has been drained to fill a retort. There is still wax in the chamber.	
Not molten	The wax in the chamber has not melted and is unavailable.	

3.3.1.3 Retort Icons

Figure 3-6: Retort icon on the **Status** screen

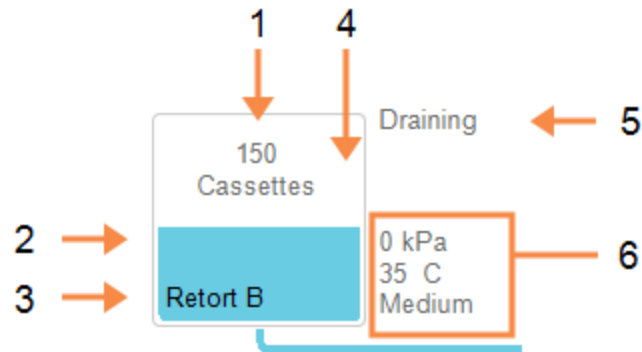

Legend

- 1 The number of cassettes in the retort.
- 2 Color-coded for reagent group currently in the retort.
- 3 Retort name.

Legend

- 4 Color or other pattern shows retort state (see below).
- 5 Current retort operation.
- 6 Retort pressure, temperature and stirrer speed (Supervisor access level only).

The current operation affecting a retort is displayed beside the retort's icon and could be:

- **Ready** - the retort is available for any new action
- **Reserved** - a protocol is loaded but has not yet started
- **Processing** - the retort is currently running a protocol
- **Completed** - the retort has completed the loaded protocol
- **Drying** - the retort is being dried as the final step of a cleaning protocol
- **Filling** - the retort is currently filling
- **Draining** - the retort is currently draining
- **Pending (drain or fill)** - the retort is waiting for resources to perform a fill or drain
- **Abandoning** - the retort is abandoning the current action
- **Unavailable** - the retort cannot be used. Contact your service representative.

The seven possible retort states are illustrated and explained in [Table 3-1](#) below.

Table 3-1: Retort states

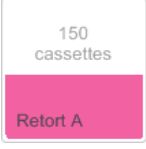
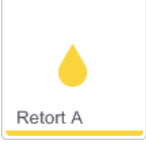
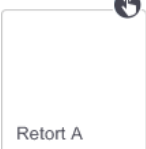
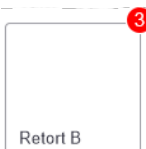
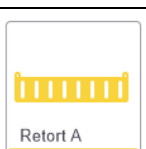
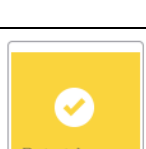
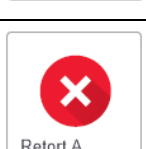
	Means	Icon
Full	The retort contains the correct amount of wax or reagent for the specified basket level.	
Part full	The reagent or wax level is between full and empty. This usually occurs during a fill or drain operation.	
Empty	The retort is drained but contains residue.	
Clean	There is no residue in the retort. This only occurs after a cleaning protocol. The retort is now ready for another protocol run.	
With identified baskets	The retort is ready for another protocol run and the ID of at least one of the baskets for the run has been entered. The number in the red circle is the number of baskets for which an ID has been entered.	
Protocol run finished successfully; awaiting tissue removal	A protocol run has been completed but you are yet to confirm that all tissue has been removed from the retort.	
Protocol run finished successfully; tissue removed	A protocol run has been completed, but the retort has not been drained.	
Retort inoperative	A red cross over a retort indicates that a hardware failure has occurred and the retort is unavailable. Contact your service representative.	

3.3.2 Protocol Panels

Panels on each side of the **Status** screen show the steps of the protocols loaded for each retort. Use the panels to load and unload protocols, start a processing run, and pause a run. You can also monitor the progress of a run.

You can view the panels in two modes: standard ([Figure 3-7](#)) and expanded ([Figure 3-8](#)).

Figure 3-7: Protocol panel: standard mode

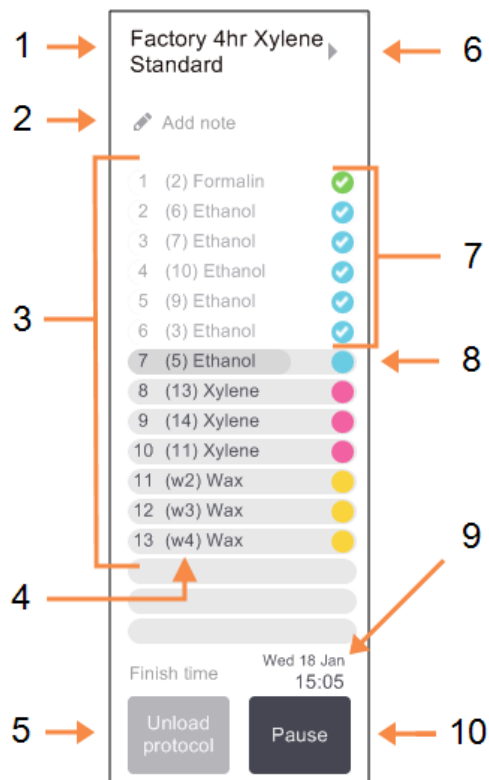

Legend

- 1 Protocol name
- 2 Optional note space
- 3 Protocol steps
- 4 The station scheduled for the step (a different station may be used)
- 5 **Select / Unload protocol:** load and unload protocols (disabled while the protocol is running)
- 6 **Extended mode:** tap protocol name or arrow to expand protocol panel
- 7 Completed steps are checked
- 8 Shaded progress bar shows progress through the current step
- 9 Protocol finish time
- 10 **Run / Pause:** start a loaded protocol, or pause a running protocol

In expanded mode the protocol notes, processing time, and step details are also shown.

Figure 3-8: Protocol panel: extended mode

Factory 4hr Xylene Standard

Pre-defined protocol. Validated EB 21 Sep 2016

	Reagent	min	°C	P/V	Stirrer
1	(2) Formalin	10	45 °C	Amb.	Med
2	(6) Ethanol	1	Amb.	Amb.	Med
3	(7) Ethanol	1	Amb.	Amb.	Med
4	(10) Ethanol	1	Amb.	Amb.	Med
5	(9) Ethanol	20	45 °C	Amb.	Med
6	(3) Ethanol	20	45 °C	Amb.	Med
7	(5) Ethanol	45	45 °C	Amb.	Med
8	(14) Xylene	1	Amb.	Amb.	Med
9	(11) Xylene	10	45 °C	Amb.	Med
10	(12) Xylene	45	45 °C	Amb.	Med
11	(w1) Wax	10	65 °C	V	Med
12	(w3) Wax	10	65 °C	V	Med
13	(w4) Wax	40	65 °C	V	Med

Processing time: 04:01:00

Unload protocol | Pause

Finish time: Tuesday 24 Jan 20:30

Legend

- 1 Protocol notes
- 2 Step duration, temperature, pressure/vacuum, and stirrer speed
- 3 Processing time: total time to run protocol

3.4 Protocol Run Options

You can schedule a protocol run so that it finishes at a convenient time. You can also modify the protocol to start at the second or later steps, and to change step durations. See:

- [3.4.1 - Scheduling Protocols](#)
- [3.4.2 - Changing the Starting Step for a Single Run](#)
- [3.4.3 - Changing the Step Time for a Single Run](#)

3.4.1 Scheduling Protocols

You schedule a protocol run in the **Scheduling** dialog box. The dialog box opens after you have loaded the protocol, tapped **Run**, and cleared any warning messages.

The **Scheduling** dialog box gives access to the **Edit the run steps** dialog box where you can edit some protocol features for the run (see [3.4.2 - Changing the Starting Step for a Single Run](#)).

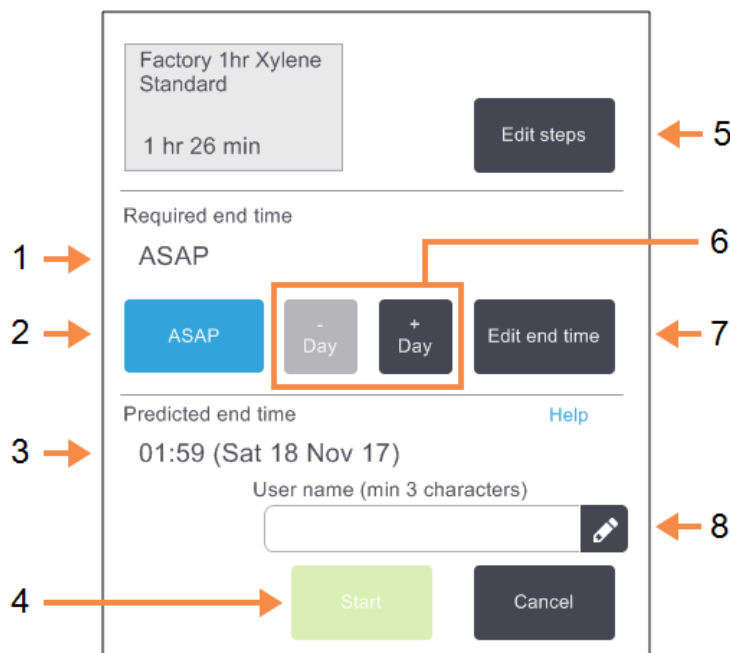
Figure 3-9: The **Scheduling** dialog box**Legend**

- 1 **Required end time:**
The protocol end time you have set.
- 2 **ASAP:**
Start the run as soon as possible.
- 3 **Predicted end time:**
The end time predicted by the system after scheduling.
- 4 **Start:**
Start the protocol run.

Legend

- 5 **Edit steps:**
Edit the protocol. Refer to [3.4.3 - Changing the Step Time for a Single Run](#).
- 6 **- / + Day:**
Keep the current end time but change its day.
- 7 **Edit end time:**
Change the end time for the run or set a new default end time for the retort.
- 8 **User name:**
Add your user name to enable the **Start** button.



Note: User name is a unique identifier for each user. The user name entered here must match the user name created for you. Contact your Supervisor if you don't know or forgot your user name.

Each retort has a default scheduling setting. The **Scheduling** dialog box always opens showing the retort's default setting. You can accept the default or change the setting for the run: there are options to set a different end time or run the protocol as soon as possible (the **ASAP** option). You can also change the retort defaults from the **Scheduling** dialog box.

The system considers the required end time as the latest acceptable protocol completion time. To avoid resource clashes, protocols may be scheduled to finish earlier than the required end time. A red highlight indicates that the required end time is not possible and a later end time has been set.

The required end time for cleaning protocols is always set to **ASAP**.



Note: Before starting a protocol, always check that the predicted end time is suitable.

3.4.1.1 How To Schedule a Protocol Run

When the **Scheduling** dialog box opens, the retort's default scheduling is shown.

- If the default end time is set to **ASAP** the protocol is scheduled to end at the earliest possible time.
- If the default setting is a specific time of day, the dialog box defaults to that time on the following day.

You have four options:

- Accept the default values as they are.

Edit the protocol for the run if required (see [3.4.2 - Changing the Starting Step for a Single Run](#)) and then tap **Start** to begin the run.

- Keep the default time but change the day the protocol will run.

Tap the **+ day** or **– day** button to keep the default end time but change the day.

If the default setting is a specific time of day, the dialog box opens with the run set to the following day. To run the protocol on the current day tap the **– day** button once. Depending on the time you do this, the new end time may not be possible. If so, the **Predicted end time** is highlighted in red.

- Start the run as soon as possible.

Tap the **ASAP** button.

The protocol will normally start immediately. However, if there is a reagent clash caused by the protocol running in the other retort, the actual start of the protocol may be delayed (see [3.6.1 - Delayed End Times and Initial Fills](#)).

- Set a new end time.

Tap the **Edit end time** button to open the **Enter required end time** dialog box. (See the next section for instructions.)

3.4.1.2 Entering a New End Time or Default Scheduling Setting

You can change the end time for the currently selected run in the **Enter required end time** dialog box, opened from the **Scheduling** dialog box by tapping the **Edit end time** button.

You can also specify that a scheduling setting becomes the new default for the current retort.

Figure 3-10: The **Enter required end time** dialog box

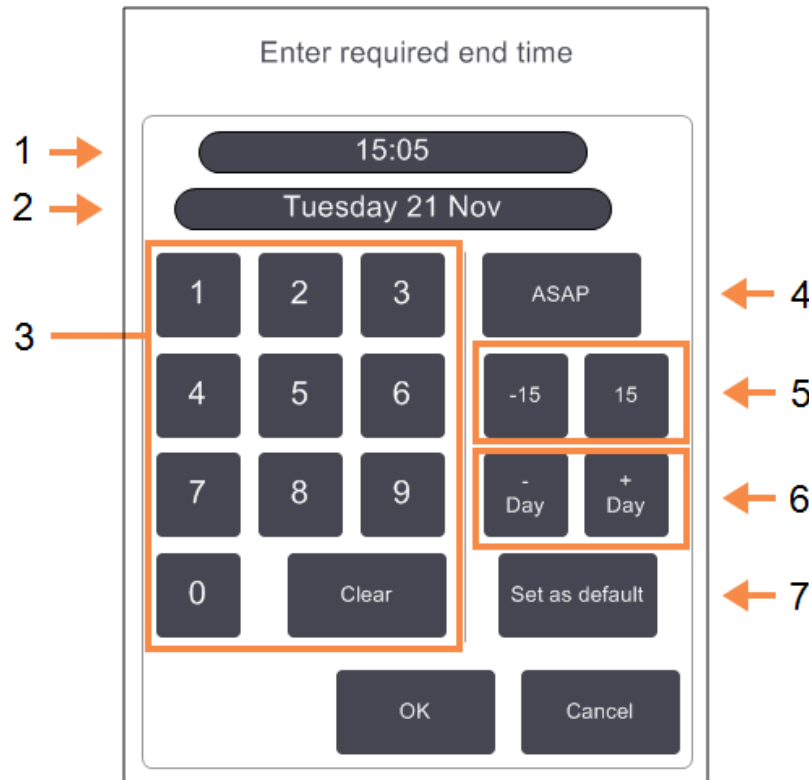

Legend

- 1 Scheduled time of day
- 2 Scheduled day
- 3 Keypad to enter a new time. Use the 24-hour format.
- 4 **ASAP:**
Use if setting the "as soon as possible" option as the retort default.

Legend

- 5 **-/+ 15:**
Change the scheduled time of day in 15 minute increments.
- 6 **-/+ Day:**
Change the scheduled day.
- 7 **Set as default:**
Set the time of day currently entered or "as soon as possible" setting as the retort default.

- To set a new end time, use the keypad to enter the time (in 24-hour format) or use the **-15** or **+15** buttons to increment the time in 15 minute steps. Use the **+ Day** and **- Day** buttons to change the day. Tap **OK** when finished.
- To set a new retort scheduling default, enter a time of day (as you would to change the end time for an individual run) or tap **ASAP**. The day is not relevant to the default setting. Tap **Set as default** then **OK**.

3.4.2 Changing the Starting Step for a Single Run

After selecting a protocol, and just before the protocol starts, you can change the step from which it starts.

1. Start a protocol run as normal from the **Status** screen and continue until the **Scheduling** dialog box opens. Tap **Edit steps** to open the **Edit the run steps** dialog box.

Figure 3-11: **Edit the run steps** dialog box

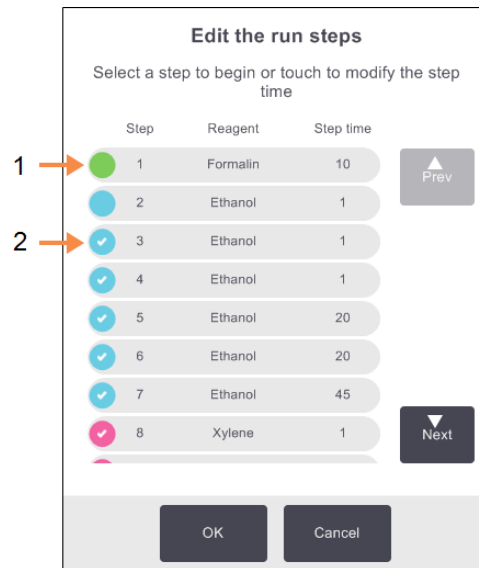

Legend

- 1 No check in the circle indicates that this step will be skipped.

Legend

- 2 Tap the icon of the step that will be the first to run in the protocol.

2. To skip one or more protocol steps, tap the step icon for the step that you want the protocol to start with. (A step icon is a colored circle at the left of the dialog box.) Steps prior to this are unchecked to show they will not run.

The reagent selected as the new first step will be used for the initial fill, if required (see [3.6.1 - Delayed End Times and Initial Fills](#)).



WARNING: Bearing in mind the preparation that the tissue has already received, check that the reagent to be used in the new first step is suitable (in type and concentration).

3. Tap **OK**. The **Scheduling** dialog box appears. You can now schedule the run.



Note: Skipping steps will affect protocol scheduling. Confirm that the new **Predicted end time** shown in the **Scheduling** dialog box is acceptable before continuing.



Note: If you want to revert to the original protocol at this stage, you will need to unload the changed protocol and re-load the original.

3.4.3 Changing the Step Time for a Single Run

After selecting a protocol, and just before the protocol starts, you can change the duration of one or more steps in the protocol.

1. Start a protocol run as normal from the **Status** screen and continue until the **Scheduling** dialog box opens. Tap **Edit** steps to open the **Edit the run steps** dialog box.

Figure 3-12: **Edit the run steps** dialog box

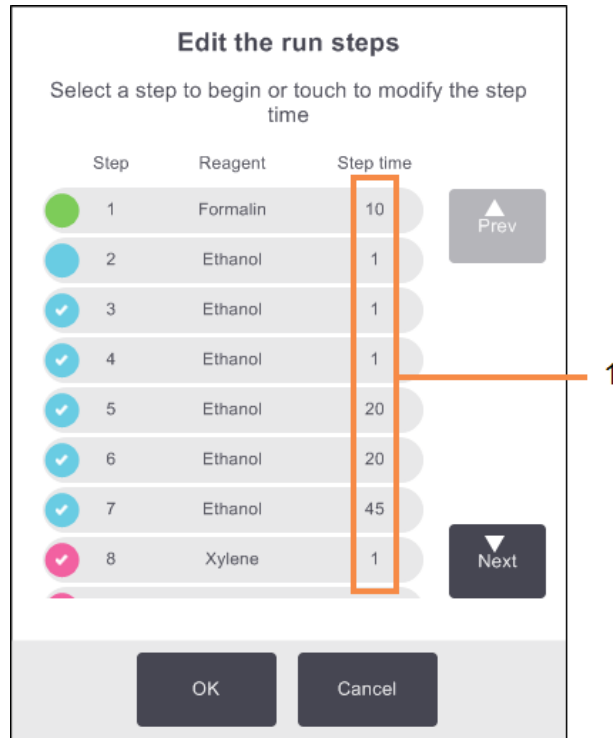

Legend

- 1 Tap on a step time to open the **Duration** dialog box where you can set a new step duration.
- 2 To change a step time, tap the current step time.
- 3 Set a new duration in the **Duration** dialog box.
- 4 Tap **Done** and repeat from [step 2](#) above if you want to change any other step duration.



CAUTION:

Be careful not to tap a step icon at the left of the dialog box. (A step icon is a colored circle. It may or may not enclose a checkmark.) Tapping a step icon could change the protocol's starting step.

5. Tap **OK**. The **Scheduling** dialog box appears. You can now schedule the run.



Note:

Changing step durations will affect protocol scheduling. Confirm that the new **Predicted end time** shown in the **Scheduling** dialog box is acceptable before proceeding.

3.5 Pausing and Abandoning Protocols

To stop a protocol that has started, tap one of the **Pause** buttons on the **Status** screen protocol panels. When you tap either **Pause** button, protocols in both retorts stop running and the **Paused** dialog box opens with a number of options:

- Abandon all processing or just the protocol in one retort.
- Access a retort—for example to add more cassettes—and then resume the protocol running in it.
- Vent the wax baths so you can open them.

After you pause the instrument you have five minutes to select an option, after which processing automatically resumes.

Figure 3-13: **Instrument paused** dialog box

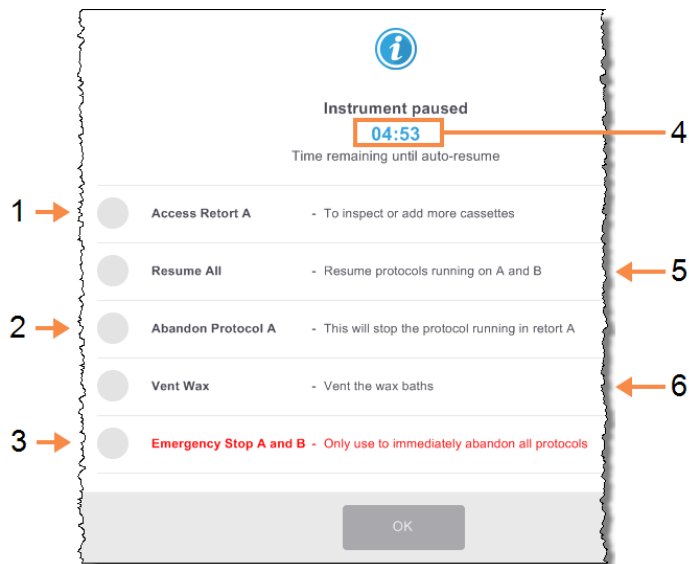

Legend

- 1 Access retort:**
prepare the retort to allow you to open it, e.g. to add more cassettes
- 2 Abandon:**
abandon the protocol running in the retort. The protocol in the other retort will resume.
- 3 Emergency stop:**
abandon protocols in both retorts

Legend

- 4 5-minute count down:**
if you do not select an option within 5 minutes, processing automatically resumes
- 5 Resume:**
continue processing in both retorts
- 6 Vent wax:**
vent the wax chambers so that you can open them

**WARNING:**

Take care if opening a retort or wax chamber after pausing the instrument. Retorts may contain very hot fluid, hazardous reagents and vapors. Read any warning messages—for example, the retort is above safe access temperature—and take appropriate precautions before continuing.

Note that pausing a protocol places the retort in a safe state (ambient pressure or vacuum). Pausing the protocol is strongly recommended before you open the retort lid.

3.5.1 Emergency Stop and Abandon

After you have paused the instrument you can abandon all protocols with the **Emergency stop** button. Note that this does not shut down or remove power from the instrument (see [2.1 - Switching On and Shutting Down](#)).

Alternatively, abandon the protocol run in the selected retort only with the appropriate **Abandon** button. Any protocol running in the other retort will resume.

When processing stops, the PELORIS 3 goes through the same routines it does at the end of a normal protocol run. It prompts you to drain the retort (if full), remove cassettes, and run a cleaning protocol. However, there will be an additional prompt during the recovery steps (with on-screen help to assist you). See [3.5.3 - Recovering from an Abandoned Run](#).

**Note:**

After abandoning a protocol, you may wish to run a reprocessing protocol to recover your cassettes. In this case do not remove your cassettes or run a cleaning protocol when prompted to do so. Appropriate action after an abandoned run can be found in [3.5.3 - Recovering from an Abandoned Run](#).

**Note:**

If the last reagent was a fixative, you can skip the cleaning protocol, as the residue will not prevent you running a typical processing protocol. If you decide to run a cleaning protocol, set the first step to a cleaning alcohol. Cleaning solvents are incompatible with fixatives.

3.5.2 Access Retort

You can access retorts on a paused instrument (to, for example, add or retrieve samples). If space permits, you can add cassettes to one or more baskets, and add one or more baskets to one or both retorts. If you are adding baskets, you can enter their ID—either by scanning or by direct entry—before resuming the run.

If you wish to add extra cassettes or baskets, it is recommended that you drain the retort before opening it.

**CAUTION:**

Take care when adding fixed samples to a running protocol. The additional fixative will contaminate the reagent used in the current step and this contamination will not be tracked by the reagent management system.

**CAUTION:**

The further a protocol has progressed before you add more samples, the more compromised is the processing quality for those samples. We therefore recommend that you only add samples during fixative steps or during the first dehydrant step.

To access a retort while the instrument is processing:

1. Pause the instrument by tapping one of the **Pause** buttons on the **Status** screen.
2. Tap the appropriate **Access retort** button in the **Paused** dialog box.
3. Select to drain the retort or not in the **The retort is not empty** dialog box.
Follow the prompt to wait if draining.
4. When the **Retort Baskets** dialog box opens, remove the baskets from the retort and add or retrieve cassettes, as required.
5. Return the baskets to the retort (scan or enter IDs if necessary) and tap **OK** in the **Retort Baskets** dialog box.
6. Tap **Resume All** in the **Paused** dialog to resume the protocol.

3.5.3 Recovering from an Abandoned Run

1. Gather information
 - Check the **Run Details** report (**Admin > Reports > Run Details Report**).
 - Check the event logs (**Admin > Event Logs**).
2. Decide
 - Based on the information in the report and the logs, should you continue to process tissue on the instrument?
 - If the instrument has failed, remove the tissue and then use the **Run Details** report to decide on the step to continue with on another instrument.
 - If the instrument is fine but a reagent is missing or its level is low, deal with the issue and then use the run **Run Details** report to decide on the step to continue with.
3. Act
 - Based on your decision, either (a) remove the tissue from instrument and call service or (b) continue processing by loading a protocol and using the **Edit steps** function to select the appropriate starting step (see [3.4.2 - Changing the Starting Step for a Single Run](#)).

3.6 Retort Scheduling

The PELORIS 3 allows you to run protocols simultaneously in both retorts. The automatic scheduling function attempts to assign reagent stations and start times so that there are no clashes. It may alter your requested end time by starting the protocol early or by delaying one or more steps (see [3.6.1 - Delayed End Times and Initial Fills](#)).

When a second protocol starts, the reagent stations assigned when the protocol was loaded may change. This occurs because the first protocol's reagent requirements always take precedence.

It is sometimes not possible to schedule a second protocol. This situation, and possible remedies, are discussed in [3.6.2 - Unavoidable Reagent Clashes](#). Also, protocols will sometimes fail if a reagent station unexpectedly becomes unavailable. See [3.6.3 - Unavailable Reagents](#) for ways to avoid this situation.

This section contains the following subsections:

- [3.6.1 - Delayed End Times and Initial Fills](#)
- [3.6.2 - Unavoidable Reagent Clashes](#)
- [3.6.3 - Unavailable Reagents](#)

3.6.1 Delayed End Times and Initial Fills

Protocols do not need to start immediately and it is possible to set a required end time that necessitates a delay before the protocol begins. This delay can extend to many days. Also, when selecting the **ASAP** (As Soon As Possible) scheduling option, or if you have requested an end time that is not achievable, the instrument may be forced to delay the start of the protocol. During the protocol delay, the instrument will protect your cassettes by covering them with reagent. This process is called an *initial fill*.

During the initial fill, the retort is filled with the first scheduled reagent (usually a fixative) to protect the samples. Unless the reagent is wax, no heating or agitation occurs. If the initial step is wax (for reprocessing or wax-only protocols), the retort temperature will be set to wax standby, and the stirrer will be set to the first step's speed. Once the initial fill period is over, the protocol will run normally and will finish at the predicted end time.

We recommend that all protocols start with a fixative step (even if it is very short); thus a fixative is used for any initial fill. If there is no fixative step, an initial fill may leave your tissue covered with dehydrant for a long time, and this could cause the tissue to become hard and brittle.

3.6.2 Unavoidable Reagent Clashes

Unavoidable clashes occur when there are insufficient reagent stations available for both protocols to satisfy the reagent selection rules (see [4.1.2 - Reagent Selection Method](#)). This mostly occurs when you are using type-based or station-based protocols, as they have limited station assignment flexibility.

Always ensure that there are sufficient stations of the first reagent group or type so that a station is available for an initial fill.

3.6.3 Unavailable Reagents

Once a protocol starts, group-based and type-based protocols may reassign stations to recover from errors caused by unavailable reagents (for example, when a bottle is locked by a density meter). This reassignment may use reagents assigned to the other protocol.



Note: Station-based protocols will fail if an assigned reagent becomes unavailable. Type-based protocols will fail if there is only one station with an assigned type and it becomes unavailable.

Some common causes of station unavailability, and ways to avoid them, are described below.

- The station contains insufficient reagent.
Prior to each run, check that the reagent level in each station is sufficient for the current fill level. (Go to **Reagents > Stations** for the current level.)
- A bottle scheduled for use is removed from the reagent cabinet.
For safety reasons you should not remove any bottle while a protocol is running. However, if you choose to do so, you must make sure the bottle you intend to remove is not scheduled for use in either retort.
- A wax station is not molten at the time it is required.
Make sure there is adequate time for the wax to melt and that the correct wax station state is set (see [5.3.2 - Setting Reagent Station Properties](#)).
- A density meter has calculated a concentration and it does not match the concentration recorded for the reagent on the **Reagent Stations** screen (**Reagents > Stations**).
The contents of the bottle will need to be changed or checked—by operators or supervisors—and the concentration updated by a supervisor. The concentration will be rechecked by the density meters.

4. Protocol Setup

Protocols control all aspects of tissue processing. This chapter gives an overview of the default PELORIS 3 protocols and how to edit and view them. It also explains how you can create our own protocols.

The chapter contains the following subsections:

- [4.1 - Protocol Overview](#)
- [4.2 - Creating, Editing and Viewing Protocols](#)

4.1 Protocol Overview

A protocol consists of series of steps that will be applied to tissue in a retort. In each step (with one exception) the retort is filled with reagent and held for a time under conditions controlled by the protocol. Each protocol step specifies:

- the reagent used
- the time the reagent is in the retort
- the temperature of the reagent
- the retort pressure: ambient, pressurized or vacuum, or cycling between pressurized and vacuum
- the retort stirrer speed
- the drip time, that is, the time allowed for reagent to drip from the cassettes and retort walls before the protocol begins the next step. Longer drip times reduce carryover.

The one step type that is an exception is the final dry step of a cleaning protocol, where no reagent is used.

There are five protocol types. A protocol's type sets limits on which reagents can be used and the order of their use.

Other protocol properties are the reagent selection method and a mandatory carryover value. Protocol properties and associated actions are described in the following subsections:

- [4.1.1 - Protocol Types](#)
- [4.1.2 - Reagent Selection Method](#)
- [4.1.3 - Pre-defined Protocols](#)
- [4.1.4 - Protocol Validation](#)
- [4.1.5 - Carryover Setting](#)
- [4.1.6 - Protocol Files](#)

4.1.1 Protocol Types

The PELORIS 3 uses five protocol types, each for a different processing function. The protocol types allow different reagent sequences and temperature ranges (see [8.5 - Reagent Compatibility Tables](#) and [8.4 - Protocol Step Temperatures](#)). Once a protocol is created, you cannot change its type.

The protocol types are:

- **Standard** - conventional tissue-processing sequences using a clearer such as xylene. These protocols are suitable for normal processing requirements and can include defatting steps.
- **Standard reprocessing** - to recover under-processed tissue on an instrument configured for standard processing. These protocols start with cleaning reagents before initiating a standard tissue-processing sequence.
- **Xylene-free** - protocols with high-temperature wax steps and advanced processing techniques to process tissue without conventional clearing steps. These are suitable for normal processing requirements.
- **Xylene-free reprocessing** - to recover under-processed tissue on an instrument configured for xylene-free processing. These protocols start with cleaning reagents before initiating a xylene-free tissue processing sequence.
- **Cleaning** - protocols to clean the retorts and reagent lines. Always run a cleaning protocol as soon as possible after wax has been in the retort. See [3.2 - Cleaning Protocols](#) for further information.

See [4.2.1.1 - Protocol Icons](#) for the icons used for each protocol type.

Note the following points:

- **Xylene-free reagent selection** - xylene-free protocols use two sets of dehydrants rather than dehydrant followed by clearer, as used in standard protocols. This means xylene-free protocols cannot use group reagent selection (see [4.1.2 - Reagent Selection Method](#)).
- **Xylene-free baskets** - always use spaced cassette baskets for xylene-free protocols.
- **Reprocessing carryover** - during reprocessing protocols, there is significant reagent carry-over following the use of cleaning agents. After running a reprocessing protocol, you should replace the first three processing reagents that are used after the last cleaning reagent.

4.1.2 Reagent Selection Method

All protocols use one of three reagent-selection methods: group, type or station. Once a protocol is created, you cannot change its reagent-selection method.

A protocol's reagent-selection method determines the way the system selects reagent stations when the protocol is run. With the station selection method, you define exactly the station to use for each step, so the system makes no choices. For group and type selection, the system selects the best station from those available to it (see [4.1.2.1 - Station Selection Rules](#) below). In summary:

- **Group selection** — the system selects from those stations with reagent of the group. A station's reagent name (its type) is not used for selection, only the reagent group and concentration.

For example, if you have bottles with reagent types Ethanol 70% and Ethanol 90% on the instrument, the system will pick an in-threshold Ethanol 90% bottle for the first dehydrant step if that bottle has the lowest concentration. Both reagent types are dehydrants, so are equal candidates for dehydrant steps.

- **Type selection** — the system selects from those stations with reagent of the type defined for the protocol step. Station reagent names (i.e. types) and concentration are used for selection.
Using the example above, with Ethanol 70% and Ethanol 90% bottles on the instrument, if the first dehydrant step in the protocol specifies Ethanol 70%, then the Ethanol 70% bottle with the lowest concentration will be used, even if there is an Ethanol 90% bottle with lower concentration. Because Ethanol 70% and Ethanol 90% are different reagent types, the system does not consider them equal.
- **Station selection** — the system uses the stations defined in the protocol. (Typically, you define the bottles in order: bottle 1 first, then bottle 2, 3, etc.). Stations are defined by number, so neither the name of the reagent in a station (its type) nor the reagent group are used for selection.
Again using the example above, if there are two Ethanol 70% bottles on the instrument and the first dehydrant step of the protocol specifies the first of these bottles, that bottle will be used regardless of the concentration of reagent in the other bottle.

4.1.2.1 Station Selection Rules

The system uses the following rules to select stations for protocols with group- and type-reagent selection. "Sequence", as used below, means a series of protocol steps using the same reagent group or reagent type.

- The first step of a sequence uses the lowest concentration station available.
- The last step of a sequence uses the highest concentration station available.
- Intermediate steps in a sequence use the lowest concentration station that has not already been used.
- Where there is a single step for a particular reagent group or type, the highest concentration station is used.

Stations that have exceeded their use thresholds (and are not locked) are not selected unless there is no other station available.

4.1.2.2 Reagent Selection Methods Compared

When creating protocols, you should decide which method best suits your processing needs and reagent management strategy. Note, however, that xylene-free protocols cannot use group selection. Xylene-free protocols use dehydrants for two different functions and group selection cannot differentiate these.

Group selection ensures optimal reagent selection with minimal management. You get maximal use from reagents and, with the widest range of stations to select from, scheduling conflicts are minimized. You must, however, take care when using group selection, as the system may use a reagent type you wanted to reserve for a particular purpose. (For example, a 70% ethanol bottle you want to place at the start of a sequence may get scheduled later if another ethanol bottle has a lower concentration.) If that is the case, use the type- or station-selection method.

Type selection offers the same sorts of benefits as group selection: optimal selection of reagents according to concentration, minimal reagent management, efficient reagent use, and minimal scheduling conflicts. However, the system selects from a smaller range of stations, so the benefits are reduced. On the other hand, you have greater control over reagent selection.

Station selection gives you total control over reagent selection. However, as reagents degrade, you may need to rearrange bottles between protocols if you want to ensure the most suitable reagents are used. This is a significant management burden and prone to error. Also, the station selection method does not allow the instrument any flexibility when scheduling protocols. For example, it will not be able to recover from a processing error caused by unexpected reagent unavailability.



Note: Station selection protocols are not recommended for overnight processing. If a reagent becomes unavailable for any reason, then the protocol cannot finish.



Note: When running station-selection protocols, always check the concentration of the assigned stations before starting a run, as the concentrations may not be correctly ordered if other protocols have been run.

Your decision about the reagent-selection method must be made in combination with decisions about how many, and which, reagent types you use, and the concentration thresholds to set for them. Note that all the pre-defined protocols in the PELORIS 3 system use type selection, but with recommended bottle configurations that have the minimal number of reagent types (see [8.2.2 - List of Pre-defined Protocols](#) and [8.3 - Station Configurations](#)). This combination provides a system that is similar to group selection, with all the consequent benefits.

4.1.3 Pre-defined Protocols

Each PELORIS 3 system has 11 pre-defined protocols: 1, 2, 4, 8 and 12 hour protocols for standard processing and for xylene-free processing, and a cleaning protocol (see [8.2.2 - List of Pre-defined Protocols](#)). Like all protocols, the pre-defined protocols can be accessed by selecting **Admin > Protocols**.

The pre-defined protocols are designed for use with the bottle configurations described in [8.3 - Station Configurations](#). Leica Biosystems has extensively tested the protocols and found they give excellent results (in combination with proper reagent management and instrument maintenance). However, users should validate all protocols, including the pre-defined protocols, for use in their laboratories, as different conditions could give different outcomes.

Pre-defined protocols can be copied and the copies then be edited to suit your purposes. They will need to be renamed before they can be edited. See [4.2.3.2 - Copying Protocols](#) for directions to copy a pre-defined protocol.

4.1.4 Protocol Validation

Supervisors creating or editing protocols (or copying pre-defined protocols) can validate them in the PELORIS 3 software. This serves as a sign that the protocols have passed the laboratory's validation tests and can be used for regular clinical processing. Supervisors can also make valid protocols invalid.

Protocols that have been marked as valid can be run by operator-level users, while invalid protocols cannot. Invalid protocols can be run by supervisors.

Icons for validated protocols have a check in a green circle, while the icons for invalid protocols have a cross in a red circle:

Figure 4-1: Icon for a valid protocol

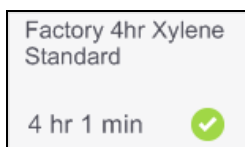

Figure 4-2: Icon for an invalid protocol



Set the protocol validity status on the **Edit protocol** screen by tapping **Validate protocol** (to validate an unvalidated protocol) or **Invalidate protocol** (to unvalidate a validated protocol).

4.1.5 Carryover Setting

When reagent drains out of a retort, a certain amount of the reagent remains in the retort and mixes with the next reagent in the protocol. The carryover setting is an estimate of the amount of a reagent that is carried over from one protocol step to the next. The PELORIS 3 reagent management system takes the carryover setting into consideration when determining reagent concentrations.

The residual reagent carried over can come from:

- Reagent retained on retort walls and baskets
- Reagent on and infiltrated into tissue
- Reagent on and infiltrated into small-tissue carriers (e.g. biopsy pads, biopsy cassettes, wraps etc.).

The reagent management system automatically calculates the carryover on retort walls and baskets, taking into account the retort fill level and drip time.

The carryover due to cassettes and tissue is calculated using the number of cassettes entered by users at the start of each run. The amount of carryover on a standard cassette is used in the calculation. Drip time is also included.

The reagent management system calculates carryover from small-tissue carriers using the protocol carryover value you set.

Carryover values are on a scale from 0 to 100:

- A setting of 0 indicates that there is no carryover due to small-tissue carriers like biopsy pads, that is, the run has only standard cassettes with no small-tissue carriers.
- A setting of 100 indicates there is carryover equivalent to having all the tissues in a run using biopsy pads. (Biopsy pads have the maximum carryover of all small-tissue carriers.)

Because biopsy pads can have up to 10 times the carryover of standard cassettes, it is important to set a truly representative carryover value in your protocols (as it is to accurately enter the number of cassettes in each run). If you set too high a carryover value, the system calculates an excessive degradation of reagents, which will require you to replace them sooner than necessary. With too low a setting, the system will consider that reagents are more pure than they are. Thus you will use reagents beyond their optimal effectiveness, resulting in poor processing quality.

Only supervisors can set carryover values. The default value is set on the **Reagent Management** screen (**Settings > Reagent Management**). The carryover value for a specific protocol can be changed on the **Edit Protocol** screen (**Admin > Protocols > Edit**). Tap the **Carryover** button and enter a number between 0 (no carryover from small-tissue carriers) and 100 (maximum carryover from small-tissue carriers).

4.1.5.1 How to Calculate Carryover Values

Carryover is dependent on the types of cassettes and other small-tissue carriers used: biopsy pads, paper or tissue inserts, mini cassettes, biopsy cassettes etc. It also depends on the proportion of these in each run.

The carryover setting is a setting for a protocol, not for a specific run, so it must be set to the average carryover value for runs that use that protocol.

The following table shows the carryover values that should be used for a range of cassettes and other tissue carriers provided by Leica Biosystems. The values in the table apply when all the tissue in the run uses the respective cassette or carrier type.

Table 4-1: Carryover values for a range of tissue carriers provided by Leica Biosystems

Leica Biosystems products	Generic description of tissue carrier	Carryover value if 100% of tissue uses carrier
Surgipath ActivFlo Routine I	Standard cassette	0
Surgipath Biopsy Pads in Surgipath ActivFlo Routine I	Biopsy pad in standard cassette	100
ActivFlo Mini Cassette in Surgipath ActivFlo Routine I	Mini cassette in standard cassette	50
Surgipath Biopsy Wraps in Surgipath ActivFlo Routine I	Biopsy wrap in standard cassette	20
Surgipath IP ActivFlo Biopsy I McCormick MC-605	Biopsy cassettes with >1 mm pore size	0

4.1.5.2 Sample Calculation

Suppose that the average run of a protocol uses the following proportions of tissue carriers:

- Surgipath ActivFlo Routine I: 40%
- Surgipath Biopsy Wraps in Surgipath ActivFlo Routine I: 60%

Multiply the proportion of each carrier by its value in the table above to calculate the additional carryover value for that carrier:

- Surgipath ActivFlo Routine I: $40\% \times 0 = 0$
- Surgipath Biopsy Wraps in Surgipath ActivFlo Routine I: $60\% \times 20 = 12$

Add the resulting values:

$$0 + 12 = 12$$

Enter a carryover value of 12 for the protocol.

4.1.5.3 Other Products

For small-tissue carriers other than those listed in [Table 4-1](#), we recommend you start with a carryover setting of 50. Use your own observations of tissue and reagent quality to refine this value. Tissue shrinkage in the block and excess solvent in the wax bath could indicate that you have too low a carryover setting.



Note: It is the responsibility of users to validate the carryover settings in their protocols.



Note: Contact your technical support representative if you require assistance applying suitable carryover settings.

4.1.6 Protocol Files

Protocols are saved in text files with a .cfg extension. You can back up these files. You can also send them to your service representative for troubleshooting.

Backed-up protocol files can be imported into the PELORIS 3.

See [6.3.1.1 - File transfer](#) for instructions on how to export and import protocol files.

4.2 Creating, Editing and Viewing Protocols

Supervisors can create and edit protocols. This is done from the **Protocol Selection** screen. Operators cannot create or edit protocols, but can view protocol details from the **Protocol Selection** screen. This section includes the following subsections:

- [4.2.1 - Protocol Selection Screen](#)
- [4.2.2 - Editing Protocols](#)
- [4.2.3 - Creating New Protocols](#)
- [4.2.4 - Viewing Protocols](#)

4.2.1 Protocol Selection Screen

Tap **Admin > Protocols** to open the **Protocol Selection** screen. From here you can access all protocol configuration options.

Figure 4-3: The **Protocol Selection** screen in Supervisor mode

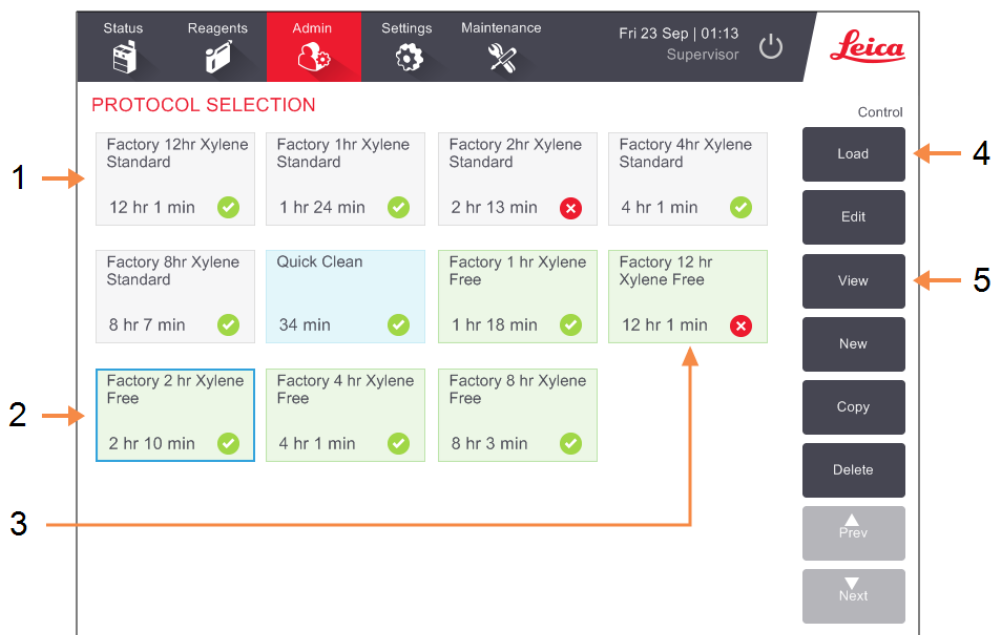

Legend

- 1 Protocol icons
- 2 Selected protocol
- 3 A protocol that has not been validated

Legend

- 4 **Load button:**
Load the selected protocol.
- 5 Protocol creation and editing buttons. Operators can tap **View** to see how the selected protocol is configured.

4.2.1.1 Protocol Icons

Each protocol is represented on the **Protocol Selection** screen by a selectable icon. Each icon shows the following protocol details:

Figure 4-4: Protocol icon



Legend

- 1 Protocol name
- 2 Protocol duration
- 3 Protocol type indicated by icon pattern and color (see below).
- 4 Validation status

Refer to [4.1.4 - Protocol Validation](#).

Icons for the five protocol types (see [4.1.1 - Protocol Types](#)) have different background patterns and colors as shown below:

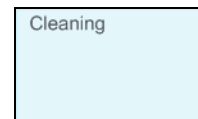
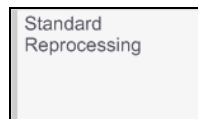
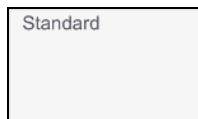

Standard (white) and Standard Reprocessing
(white with gray stripe)

Cleaning
(blue)

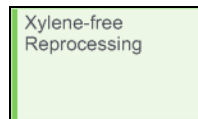
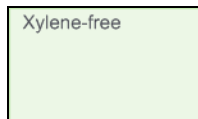

Xylene-free (green) and Xylene-free Reprocessing
(green with darker green stripe)

4.2.2 Editing Protocols

Only supervisors can edit protocols. To edit a protocol, open the **Protocol Selection** screen, select the protocol and then tap **Edit**. The **Edit Protocol** screen appears ([Figure 4-5](#)).

Steps can be added and removed, and step details (such as the duration, temperature, etc.) can be changed. The protocol's name, notes, carryover setting and validation status can also be changed. However, you cannot change the protocol type or reagent selection method, nor can you remove the dry step from a cleaning protocol.

On saving a changed protocol, the supervisor must enter their ID.

By default, a changed protocol is not a valid protocol. The laboratory will need to validate it before clinical use. Once validated, a supervisor can return to the **Edit Protocol** screen and tap the **Validate protocol** button. The protocol then becomes available to operators.

[Figure 4-5](#) and [Figure 4-6](#) show the **Edit Protocol** screen and describe its use.

Figure 4-5: **Edit Protocol** screen

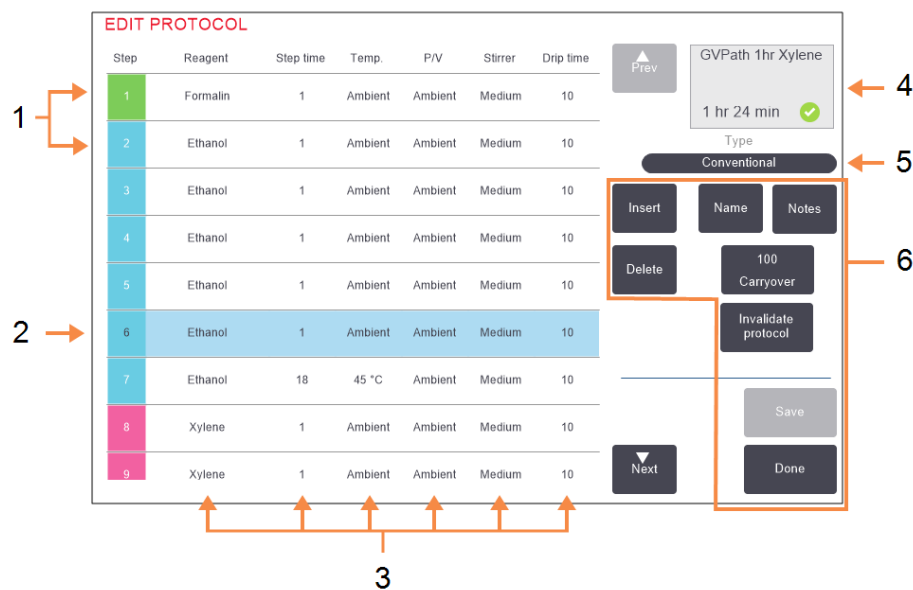

Legend

- 1 Each row represents a protocol step.
- 2 Selected step: tap a step number to select the step.
- 3 Cells in the step table show the settings for reagent time, temperature, pressure or vacuum (P/V), stirrer speed, and drip time for each step. Tap a cell to open a dialog box to change the setting.

Legend

- 4 Protocol icon: updates as protocol is edited.
- 5 Protocol type (cannot change).
- 6 Protocol configuration buttons. Refer to [Figure 4-6](#) below for further information.

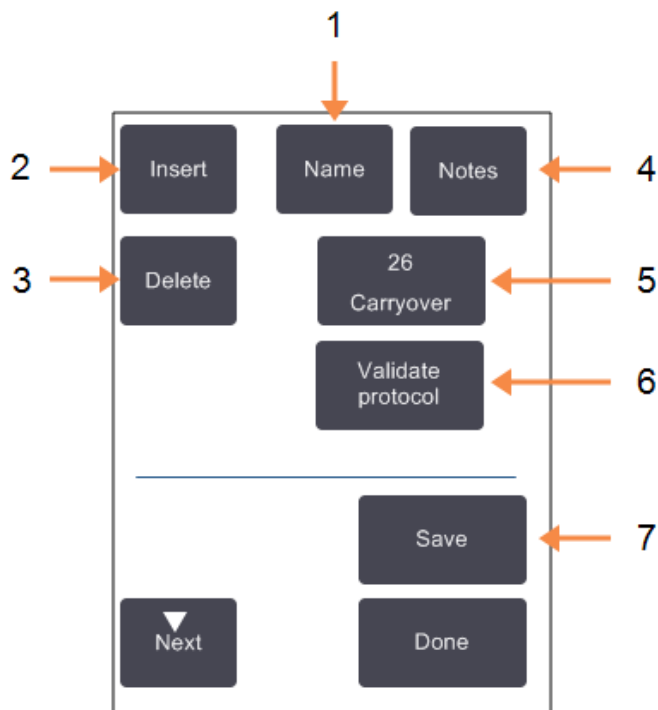
Figure 4-6: Configuration buttons on the **Edit Protocol** screen

Legend

- 1 **Name:**
Change the protocol name.
- 2 **Insert:**
Tap to insert a new step above the currently selected step.
- 3 **Delete:**
Tap to remove the currently selected step from the protocol.
- 4 **Notes:**
Enter a description or other notes for the protocol.

Legend

- 5 **Carryover:**
Set the carryover value. Refer to [4.1.5 - Carryover Setting](#).
- 6 **Validate / Invalidate protocol:**
Set the protocol as valid or invalid. Refer to [4.1.4 - Protocol Validation](#).
- 7 **Save:**
Save changes made to the protocol.

4.2.2.1 Selecting Reagents

You can change a reagent by tapping on the current reagent in the **Reagent** column in the **Edit Protocol** window. The dialog box that appears depends on the reagent selection method.

Only reagents that are compatible with the preceding protocol step (for the protocol's type) are shown. For station-based protocols, you can hide stations that have already been selected. If you choose an incompatible or hidden reagent, it is added to the protocol table with an asterisk to indicate that it is disallowed. You cannot load or run the protocol.

4.2.2.2 Group Reagent Selection

If the protocol is based on reagent groups, you can see the reagents configured for the instrument but can only select reagents by group.

Figure 4-7: **Reagent selection – Group** dialog box

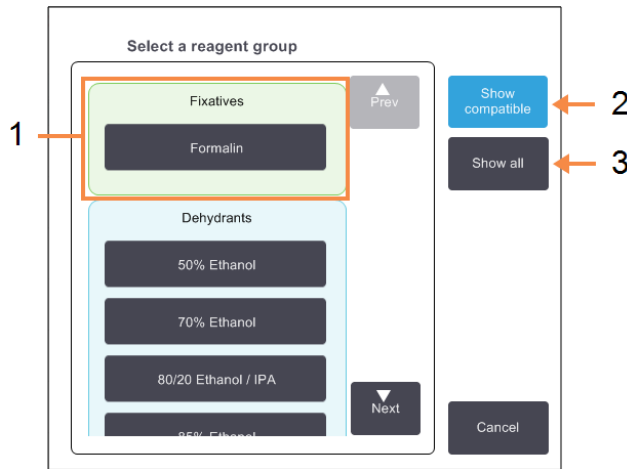

Legend

- 1 Tap a member of the group button to select the reagent group.
- 2 **Show compatible:**
Show only compatible reagent groups.
- 3 **Show all:**
Show all reagent groups.

4.2.2.3 Type Reagent Selection

If the protocol is based on reagent types, the reagents configured for the instrument are grouped by type. You can select a specific type.

Figure 4-8: **Reagent selection – Type** dialog box

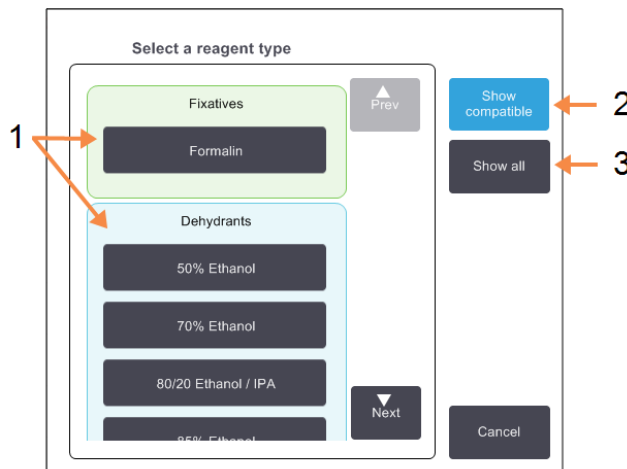

Legend

- 1 Tap on a type button to select the reagent type.
- 2 **Show compatible:**
Show only compatible reagent groups.
- 3 **Show all:**
Show all reagent groups.

4.2.2.4 Station Reagent Selection

If the protocol is based on stations, you will see all the stations configured for the instrument. Bottles that are available for selection are drawn in 3D with lids and handles. Bottles that are not available, because they have already been used or are incompatible, are drawn in 2D without lids or handles. Wax stations are similarly drawn as 3D buttons (available) or 2D icons (unavailable). Select specific stations for your protocol.

Figure 4-9: **Reagent selection – Station** dialog box

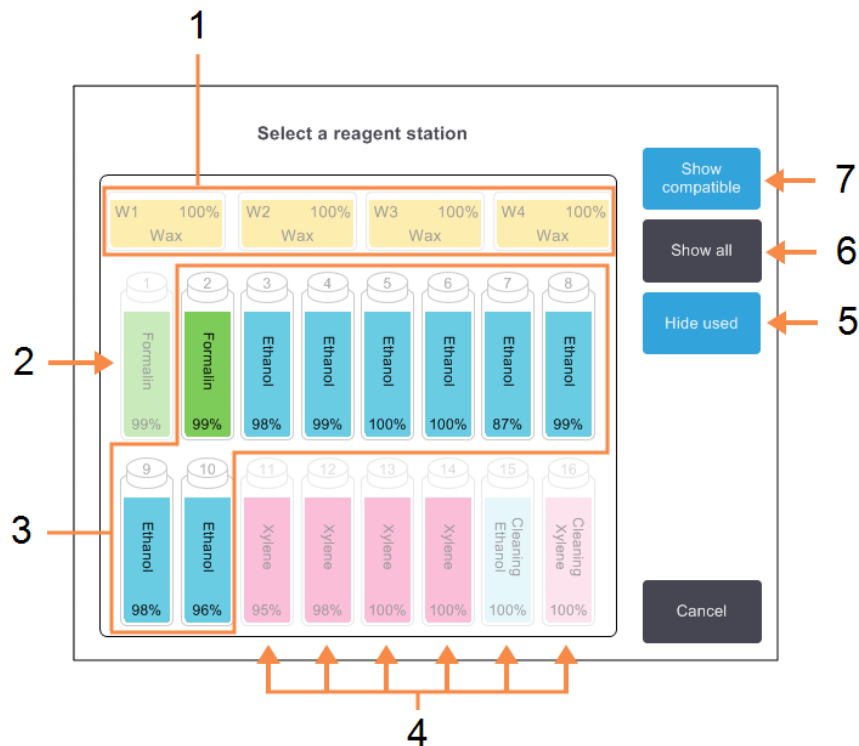

Legend

- 1 The wax chambers are all unavailable because they are not compatible with the preceding protocol step.
- 2 This station is "hidden" because it has already been used for a previous step.
- 3 These stations are available for selection.
- 4 These stations are unavailable because they are not compatible with the preceding protocol step.

Legend

- 5 **Hide used:**
Hide stations that have already been selected as unavailable.
- 6 **Show all:**
Show incompatible stations as available.
- 7 **Show compatible:**
Show only compatible stations as available.

4.2.2.5 Deleting a Protocol

Only supervisors can delete a protocol.

To delete a protocol, select its icon on the **Protocol Selection** screen and tap **Delete**.

Pre-defined protocols can be restored if required, with the normal protocol creation procedure. Other protocols cannot be retrieved, unless you have copied them to an external device. You can then import the protocol using the file transfer functions.

4.2.3 Creating New Protocols

Only supervisors can create new protocols.

You can create new protocols from scratch, or copy and modify an existing protocol (pre-defined or otherwise). Make sure you select the right protocol type and reagent selection method when you start (or copy a protocol of the right type and reagent selection method) because these settings cannot be changed after you have started to configure the new protocol.

**WARNING:**

Do not set new protocols as validated until they have passed the validation procedures for your laboratory. Only then should you edit the protocol to set it as valid, making it available to operators for clinical use (see [4.1.4 - Protocol Validation](#)). Use of non-validated protocols may result in tissue damage or loss.

4.2.3.1 Creating New Protocols From Scratch

1. Open the **Protocol Selection** screen (**Admin > Protocols**) and tap **New**.
2. Select the protocol type (see [4.1.1 - Protocol Types](#))
3. Enter a name for the protocol.
4. Choose a reagent selection method (see [4.1.2 - Reagent Selection Method](#)).
A series of dialog boxes will now guide you through creating the first step.
5. Tap the next row in the protocol table to add the second step.
You are prompted to supply the reagent and step duration. Other step properties (pressure, stirrer etc.) are inherited from the previous step. Tap the appropriate cell to change any of these values.
Cleaning protocols automatically have a final dry step. You cannot edit this step.
6. Add further steps as required.
7. Optionally tap the **Name** button to edit your protocol name.
8. Optionally tap the **Notes** button to add any information you want to keep with the protocol.
9. Tap the **Carryover** button and set a carryover value (see [4.1.5 - Carryover Setting](#)).
10. Tap the **Save** button to save the protocol.
11. Tap the **Done** button to finish.
12. Enter your user name. You can do this either by:
 - scanning your ID or
 - tapping the edit icon () and typing your user name with the on-screen keyboard.



Note: User name is a unique identifier for each user. The user name entered here must match the user name created for you. Contact your Supervisor if you don't know or forgot your user name.

13. The **Action Queue** window appears warning you of any actions that are required or recommended before the protocol can be used (see [Figure 4-10](#) below).

One warning always listed is that the protocol is not validated for use. By default, a newly created protocol is not a valid protocol. Your laboratory will need to validate it before clinical use. Once validated, a supervisor can go to the **Edit Protocol** screen and tap the **Validate protocol** button. The protocol then becomes available to operators (provided that any other errors listed on the **Action Queue** window have been attended to).

Figure 4-10: Action Queue window

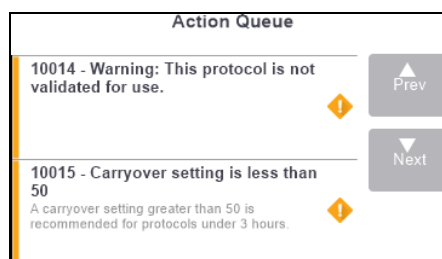

Your new protocol will now appear in the protocol selection list.

4.2.3.2 Copying Protocols

Supervisors can copy any protocol displayed on the **Protocol Selection** screen and create a new one based on it.

1. Tap **Admin > Protocols** and, on the **Protocol Selection** screen, either:
 - i. select a protocol to copy and tap **Copy**
 - OR
 - ii. tap **New > Pre-defined** icon and then select the pre-defined protocol to copy.
2. Enter a new name for your protocol.
3. A warning appears informing you that the new protocol is not yet valid for use. Tap **OK** to close the warning.

The **Edit Protocol** screen opens with the details of the copied protocol.
4. Modify the protocol (as described in [4.2.2 - Editing Protocols](#))

You cannot edit the final dry step in cleaning protocols.
5. Tap the **Save** button to save the protocol.
6. Tap the **Done** button to finish.
7. Enter your user name. You can do this either by:
 - scanning your ID or
 - tapping the edit icon () and typing your user name with the on-screen keyboard.



Note: User name is a unique identifier for each user. The user name entered here must match the user name created for you. Contact your Supervisor if you don't know or forgot your user name.

8. The **Action Queue** window appears warning you of any actions that are required or recommended before the protocol can be used.

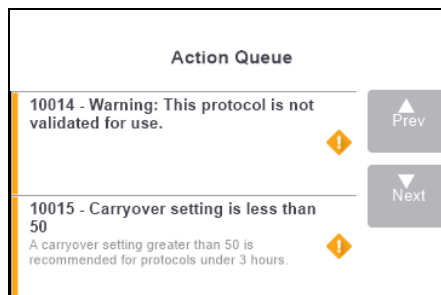

One warning always listed is that the protocol is not validated for use. By default, a newly created protocol is not a valid protocol. Your laboratory will need to validate it before clinical use. Once validated, a supervisor can go to the **Edit Protocol** screen and tap the **Validate protocol** button. The protocol then becomes available to operators (provided that any other errors listed on the **Action Queue** window have been attended to).

Your new protocol will now appear in the protocol selection list.

4.2.4 Viewing Protocols

Operator-level users cannot create or edit protocols. However, they can view the details of a protocol (including step details, notes, and the date and time the protocol was last modified).

1. Tap **Admin > Protocols**.
2. Tap once on the protocol you want to view.
3. Tap **View**.

5. Reagent Setup

This chapter gives an overview of PELORIS 3 reagent management as well as providing instructions on how to replace reagents and configure them in the software. It contains the following sections:

- [5.1 - Overview](#)
- [5.2 - Managing Reagent Types](#)
- [5.3 - Managing Reagent Stations](#)
- [5.4 - Replacing Reagents](#)

5.1 Overview

Using the right reagent at the right time, and at the right concentration, is of utmost importance for high quality tissue processing. The PELORIS 3 system has an advanced reagent management system that helps ensure consistently high quality processing while giving you workflow flexibility.

This section describes the main features of reagent management in the PELORIS 3 system:

- [5.1.1 - Reagent Groups, Types and Stations](#)
- [5.1.2 - Concentration Management](#)
- [5.1.3 - Thresholds](#)
- [5.1.4 - Recommended Reagents](#)
- [5.1.5 - Non-recommended Reagents](#)
- [5.1.6 - Tissue Marking](#)
- [5.1.7 - Reagent Compatibility](#)

5.1.1 Reagent Groups, Types and Stations

The PELORIS 3 manages reagents by groups, types and stations.

5.1.1.1 Groups

Groups specify reagent function. For example, the fixatives reagent group includes all reagents that can be used as a fixative.

There are nine factory-defined groups. Each group has a color-code that is used consistently in the PELORIS 3 software, on bottle labels and on caps. Table [Table 5-1](#) below lists the groups, functions, and colors.

Table 5-1: Reagent groups and colors

Group	Function	Color
Fixatives	Tissue preservative	Green
Dehydrants	Removes water from tissue	Blue
Defat	Removes fat deposits from tissue	Yellow
Post defat	The dehydrant used after a defatting step	Purple
Clearers	Clears the dehydrants from the tissue	Pink
Wax	The embedding medium	Orange
Cleaning solvents	First cleaning reagent	Light pink
Cleaning alcohols	Second cleaning reagent	Light blue
Cleaning water	Third retort cleaning reagent	Gray

A reagent is considered compatible in a protocol run based on its group (see [5.1.7 - Reagent Compatibility](#)).

5.1.1.2 Types

Reagent types are the specific reagents within each group, for example, formalin, xylene, Waxsol. As well as the chemical constituent, reagent-type definitions can include concentrations. For example "70% Ethanol" and "80% Ethanol" are reagent types (and defined in PELORIS 3).

Reagent types have the following properties:

- Unique name
- Default concentration: the concentration of the reagent when fresh.
- Purity thresholds: to ensure that you replace degraded reagent (see [5.1.3 - Thresholds](#)).
- Temperature thresholds: used to ensure processing quality and safe usage of the reagent (see [5.1.3 - Thresholds](#)).

The PELORIS 3 software includes a number of pre-defined reagent types. These are adequate for most laboratories. However, you can create your own reagent types if needed. Tap **Admin > Reagent Types** to define and edit reagent types (see [5.2 - Managing Reagent Types](#)).



Note: Reagent type names do not affect reagent concentration. For example, when assigning a reagent type called "Ethanol 70%" to a station, the initial concentration value would be the type's default value (probably 70%) but you can set the initial concentration to anything between 0 and 100%.

5.1.1.3 Stations

The PELORIS 3 tissue processor has 20 reagent stations: the 16 reagent bottles and the 4 wax chambers.

Each station has the following properties:

- The reagent type that the station contains
- The concentration of the reagent in the station, as calculated by the reagent management system
- The history of the station's use, namely:
 - The number of cassettes processed with the reagent in the station
 - The number of runs (that is, cycles) processed with the reagent in the station
 - The number of days the reagent has been in the station
- The station's state, namely:
 - **Dry:** the station has been completely drained leaving only a small amount of residue. It can be filled with any compatible reagent.
 - **Empty:** reagent has been removed from the station to fill a retort. Reagent in excess of the amount needed to fill the retort remains in the station.
 - **Part Full /In Use:** a reagent transfer is in progress or has been abandoned.
 - **Full:** the station holds enough reagent to fill a retort.
 - **Not molten:** for wax chambers only, the state to set when adding solid wax (see [5.4.5 - Replacing Wax](#)).
- For wax chambers only, the chamber's current temperature.

Go to **Reagents > Stations** to define reagent stations and to monitor their history and concentration (see [5.3 - Managing Reagent Stations](#)).

5.1.2 Concentration Management

The high-quality tissue processing delivered by the PELORIS 3 system is largely due to its accurate monitoring of the concentration of the reagents in each station.

5.1.2.1 Concentration in the PELORIS 3 System

Concentration is the proportion of a reagent that is of the group to which the reagent is assigned. The following examples illustrate how the concentration is determined.

- A dehydrant that is 80% ethanol (a dehydrant) and 20% water (not a dehydrant) has a concentration of 80%.
- A dehydrant that is 80% ethanol (a dehydrant) and 20% IPA (also a dehydrant) has a concentration of 100%.
- Absolute ethanol (100% dehydrant) contaminated by carryover from absolute IMS (100% dehydrant) has a concentration of 100%, as both the original reagent and the contaminant are dehydrants.
- A new xylene (100% clearer) contaminated by carryover from absolute ethanol (100% dehydrant) has a reduced concentration—typically around 94% after one cycle—as it will consist of 94% xylene (clearer) and 6% ethanol (not a clearer).

A reagent that is used early in a sequence of the same group will have rapid concentration decline, as most of the contamination it receives will be from the previous group. A reagent that is used late in a sequence will have a slower concentration decline, as most of the contamination it receives will be from the same group.

5.1.2.2 Managing Concentrations

The PELORIS 3 software uses reagent concentrations to select stations when protocols are run (unless the protocol uses station-reagent selection). It selects the station with the lowest in-threshold concentration of a reagent group or type for the first step using that group or type, then stations of increasing concentration for following steps. It always uses the highest concentration reagent for the last step before changing to another reagent group or type. The software also uses concentration information (amongst other factors) to prompt you to change reagents that have exceeded purity thresholds.

It is very important for high quality processing and efficient reagent use, that the concentration information the software uses is accurate. The software automatically tracks the concentration of the reagent in each station, updating values after each run. For it to do this effectively you must enter accurate information for it to work with. You should, for example, set realistic protocol carryover values and enter the correct number of cassettes in each run. You should also update the software accurately whenever you change reagents.

By default, the software assigns concentrations “by calculation”. This method uses the retort fill level, the number of cassettes processed, the carryover setting and the reagent groups involved to calculate the concentration in each station.

For consistently high-quality processing, always replace reagents as soon as you are prompted— with fresh reagent at the default concentration. If you remove a bottle from the instrument, always check that you enter the correct reagent information for the bottle when you return it. Supervisors can manually change station concentration values in the **Reagent > Stations** screen if they believe the value there is incorrect. Be sure that you independently verify the concentration if making such a change.

5.1.2.3 Automatic Concentration Checking

The PELORIS 3 has two density meters, one for each retort. The meters measure the concentration of certain reagents—listed in [Table 5-2](#) below—when they are first used in a processing run under either of the following conditions:

- The reagent has been replaced or
- A supervisor has changed the concentration recorded for that reagent.

If the concentration measured does not match the concentration value recorded for that bottle on the **Reagent Stations** screen, the bottle is locked (and a warning symbol is superimposed over its icon on the **Status** screen: see image at right). A locked bottle is skipped in any subsequent run (assuming, that is, that the run can continue without the locked bottle).



Note: Only ethanol (including reagent-grade ethanol and IPA–ethanol mixtures), IPA and xylene reagents will be checked by the density meters. Fixatives, cleaning reagents and reagent substitutes (such as Histolene) are not checked. [Table 5-2](#) lists the reagents that will be checked. All other reagents—including those you create yourself—will not be checked.

Table 5-2: List of reagents checked by the density meters

- | | | | |
|---------------|-----------------------|----------------|--------------------------|
| • 50% Ethanol | • 95% Ethanol | • 70% IMS | • Isopropanol |
| • 70% Ethanol | • Absolute Ethanol | • 80% IMS | • IPA |
| • 80% Ethanol | • 80/20 Ethanol / IPA | • 90% IMS | • 50/50 Ethanol / Xylene |
| • 85% Ethanol | • Ethanol | • 95% IMS | • Xylene |
| • 90% Ethanol | • 50% IMS | • Absolute IMS | |

5.1.3 Thresholds

Each reagent type has a number of thresholds. These are designed to ensure high processing quality and user safety. Supervisors can configure the thresholds by going to **Admin > Reagent Types**.

The default thresholds for the pre-defined reagent types should be adequate for most laboratories, but alternative settings may suit some laboratories better. Contact customer support for advice before changing threshold settings. Validate any threshold changes using the procedures that apply in your laboratory.

The thresholds fall into two categories:

- Purity thresholds: these set usage limits for reagents according to their purity
- Temperature thresholds: these set limits on the retort temperature.

5.1.3.1 Purity Thresholds

The PELORIS 3 uses purity thresholds to limit the use of a reagent as it becomes increasingly contaminated with reagent carried over from other groups.

When a threshold is exceeded, the software warns you that you need to replace the reagent. Under default settings, you are able to use a station with out-of-threshold reagent for one more run after such a warning. Following this the station is locked (that is, it cannot be used until fresh reagent is loaded).

Reagent purity is checked using one or more of the following four methods:

- Concentration of the reagent
- Number of cassettes processed with the reagent
- Number of processing runs the reagent has been used for
- Number of days the reagent has been loaded on the instrument.

By default, all these methods are available for you to configure for individual reagent types (done on the **Reagent Types** screen). The **Reagent threshold check** section of the **Settings > Reagent Management** screen shows the methods enabled for your system (see [Figure 5-1](#)).

Figure 5-1: Reagent threshold check methods

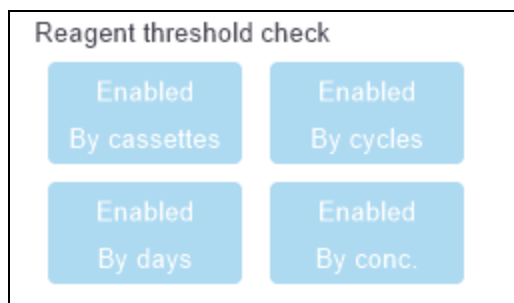

These checking-methods settings can only be changed by customer support representatives.

The checking methods are designed to monitor two types of purity threshold:

- reagent change thresholds
- final reagent thresholds.

These are explained below.

A further check of concentration purity is made by the instrument's density meters. This is explained in [5.1.2.3 - Automatic Concentration Checking](#).

Reagent Change Thresholds

Stations with reagent that has exceeded its change threshold are shown with a hatched icon on the **Status** screen (shown at the right).

The PELORIS 3 system does not use out-of-change-threshold stations unless no other stations are available. If no other stations are available, out-of-threshold stations will be used for one run before being locked. Locked stations cannot be used at all until the reagent is replaced. The system will not allow you to load protocols that require a locked station.



Final Reagent Thresholds

Final reagent thresholds set limits on the purity of the reagent that will immediately precede a change to another reagent group (or type, for protocols configured by type) in a protocol run.

Final reagent thresholds are set higher than change thresholds. This ensures minimum contamination from the preceding reagent group to the subsequent reagent group.

When a reagent type or group has exceeded its final reagent threshold (that is, no bottle within that type or group is at or above the final reagent threshold) a warning symbol in an orange diamond appears on the least pure bottle in that type or group. In addition, a message appears above that bottle.

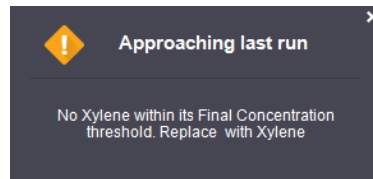

After closing the message, you can redisplay it by tapping the warning symbol on the icon of the bottle.

When you start the next run, a message appears informing you that this is the last run possible without changing the reagent that is below its final threshold:

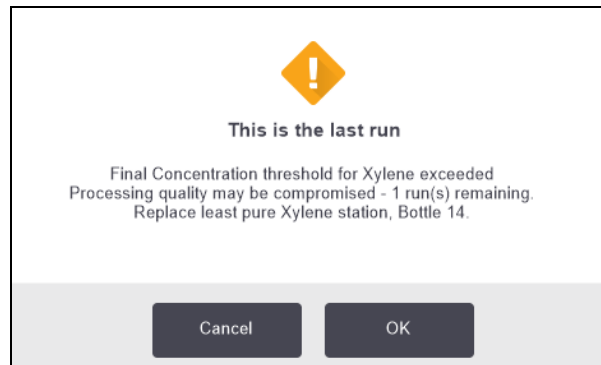

You can tap **OK** to precede with the run. A warning symbol in a red triangle appears on the icon of the bottle on the **Status** screen.

If you tap the warning symbol, a message specific to that bottle appears above the bottle (as shown below):

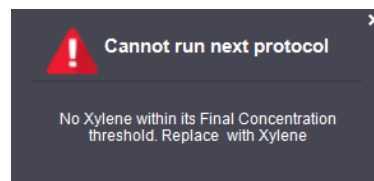

5. Reagent Setup

If you try to run another protocol that uses that reagent type or group, a message appears informing you that no further runs are possible until the reagent is changed:

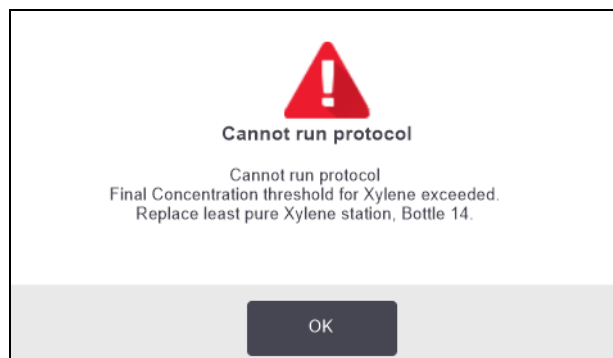

Occasionally you might see a hatched bottle with a warning symbol in an orange diamond. This occurs when both final and change thresholds have been reached, so the bottle needing to be changed is both the least pure (final change threshold) and below the reagent change threshold.



Note: When you are warned that reagent has exceeded the final threshold, replace the least pure bottle of the reagent type concerned. The bottle that exceeded the final reagent threshold, triggering the warning, will still have reagent with a relatively high concentration. It will still be acceptable for steps in the protocol sequence before the final step, so it is inefficient to replace it.

5.1.3.2 Temperature Thresholds

There are three temperature thresholds for each reagent type:

- **Ambient** - the highest allowable temperature for the reagent in the retort at ambient (and high) pressure (based on the reagent's boiling point)
- **Vacuum** - the highest allowable temperature for the reagent in the retort when the retort is evacuated (based on the reagent's boiling point)
- **Safe** - the highest temperature at which it is safe to open a retort containing the reagent.

You will not be able to create protocols that put reagents in conditions that exceed their ambient or vacuum temperature thresholds. Further, the software warns you if you are required to open a retort and the retort contains reagent above its safe temperature threshold.



WARNING: Take extreme care when deciding to change a reagent temperature threshold. Raised thresholds can lead to reagents boiling. A boiling reagent can produce excessive pressure in the instrument and increase the risk of reagent contamination and spillage. Raised thresholds can also lead to excessive fumes that overload the filtering system and cause it to fail.

5.1.4 Recommended Reagents

While each laboratory is responsible for its choice of reagents and wax, using reagents other than those recommended for PELORIS 3 can result in poor processing or compromise instrument reliability. Compliance with the following guidelines will ensure superior tissue processing.

The use of alternative reagents must be validated by your laboratory according to local or regional accreditation requirements.

Adequate fixation of tissue samples is required for optimum results. This should be achieved prior to placing the samples in the PELORIS 3 or incorporated into the fixative steps of the protocol.

The following reagents have been validated for use with the PELORIS 3.

Fixatives

- 10% Neutral Buffered Formalin (NBF)

Alcohols

- Histological-grade ethanol
- Reagent-grade ethanol
- Absolute ethanol
- Isopropyl alcohol (dehydrant)

Denatured ethanol is acceptable if:

- It is at least 99% ethanol, and
- It is denatured with methanol and/or isopropyl alcohol (IPA)

Ethanol containing acetone must not be used.

Clearing Agents

- Xylene is the recommended clearing agent.
- Xylene-free processing requires the use of isopropyl alcohol as the clearing agent. It has been fully tested and validated.

Paraffin

Use histological wax for histology, such as:

- Leica Parablocks
- Leica Paraplast

Cleaning Agents

- Use ethanol for the cleaning alcohol.
- In xylene processing mode, we recommend xylene as the cleaning solvent.
- For true xylene-free processing, we recommend Waxsol.

5.1.5 Non-recommended Reagents

The following reagents are not recommended for use with the PELORIS 3. Their use may cause instrument or tissue damage.

- Acetone
- Chloroform
- Fixatives containing Picric acid
- Histology paraffins containing dimethyl sulfoxide (DMSO), such as Paraplast Plus®
- Zinc Chloride

5.1.6 Tissue Marking

To aid in the visualization of tissue during embedding, and to mark tissue for orientation of subsequent sections, it is common for laboratories to use dyes or other marking paint at the grossing stage. However, the dyes and paints can cause dye build-up on the liquid level sensors and this can compromise performance. For this reason, it is essential that the liquid level sensors are cleaned daily. See [7.1.2 - LLS cleaning tool and wax vent plug](#) for instructions.

If you are using eosin, recommended concentrations for the different stages are given below. Testing was conducted using Surgipath Alcoholic Eosin (1%) – catalog no. 3801600.

5.1.6.1 Preference 1 – At Grossing

Use 10mL of 1% liquid eosin per liter of formalin.

You can vary the concentration to correspond with the length of the processing protocol, as some dye will be lost. A disadvantage of staining at grossing is that specimens are not immersed in dyed formalin for the same amount of time.

5.1.6.2 Preference 2 – In Fixative on PELORIS 3

Use 50mL of 1% liquid eosin per 5 L bottle of formalin.

5.1.6.3 Preference 3 – In Alcohol on PELORIS 3 (Xylene)

Use 10mL to 25mL of 1% liquid eosin per 5 L bottle of ethanol. (There are eight ethanol bottles in the recommended bottle configuration for xylene processing.)

Specimens are immersed in the marking reagent for the same amount of time, giving consistent staining. Protocols longer than two hours may cause overstaining, so reduce the eosin concentration as required.

5.1.6.4 Preference 3 – In Alcohol on PELORIS 3 (Xylene-free)

Use 250mL of 1% liquid eosin per 5 L of 85% ethanol. (There are three bottles of 85% ethanol in the recommended bottle configuration for xylene-free processing.)

Specimens are immersed in the marking reagent for the same amount of time, giving consistent staining. Protocols longer than two hours may cause overstaining, so reduce the eosin concentration as required.

5.1.7 Reagent Compatibility

Tissue processing requires the use of incompatible reagents. The PELORIS 3 software ensures that only compatible reagents are allowed to mix. Reagent mixing usually occurs when a reagent enters a retort with an **Empty** state (that is, it contains residual amounts of the previous reagent). This may happen as part of a protocol, during manual operations or during remote and fill/drain procedures.

You cannot run a protocol if the first reagent is incompatible with the retort residue. You can, however, load a protocol with an incompatible first step and then edit it so that the first reagent used is compatible with the retort residue (see [3.4.2 - Changing the Starting Step for a Single Run](#)).

The software will also prevent you from mixing incompatible reagents during remote fill/drain procedures.

Reagent compatibility varies depending on the action or protocol being undertaken. Use the reagent tables in [8.5 - Reagent Compatibility Tables](#) to check reagent compatibility before creating protocols, conducting manual operations or starting remote fill/drain procedures.

5.2 Managing Reagent Types

The PELORIS 3 software uses two lists of reagent types: an *active* list (being the reagents you use) and a *dormant* list (being all the other reagent types configured in the system). Supervisors can edit the default concentrations, the purity thresholds and temperature thresholds for active reagents (see [5.1.3 - Thresholds](#)). They can also move reagents between the active list and dormant list, and create new reagent types. Operators can only view the active list.

This section contains the following subsections:

- [5.2.1 - Pre-defined Reagents](#)
- [5.2.2 - Editing Active Reagent Types](#)
- [5.2.3 - Adding, Hiding and Deleting Reagents](#)

5.2.1 Pre-defined Reagents

A number of reagent types are pre-defined in the PELORIS 3 system. You can edit the properties of these reagent types, but they cannot be deleted. There is no requirement to use the pre-defined types; however, you can leave them on the dormant list.

If you change the properties of a pre-defined reagent type, you cannot use the software to automatically return it to its original values.

If you change the name of a pre-defined alcohol (e.g. ethanol) or clearing agent (e.g. xylene), its concentration on first use will not be checked by the density meters.

5.2.2 Editing Active Reagent Types

Use the **Reagent Types** screen (**Admin > Reagent Types**) to view and edit the active reagent types list. You also access other reagent type management options from this screen.

When you open the screen, you see the list of active reagent types. These reagent types are available to set for reagent stations. There are two views of the active list: one each for purity and temperature thresholds. (Both views show default concentrations.) Change views with the **Purity thresholds** and **Temperature thresholds** buttons. [Figure 5-2](#) and [Figure 5-3](#) show the two views.

Figure 5-2: **Reagent Types** screen, purity thresholds view, using recommended reagent types for xylene-free processing

Type	DM	Defaults					Final reagent thresholds			
		Conc.	Conc.	Cassettes	Cycles	Days	Conc.	Cassettes	Cycles	Days
Formalin	No	100.0%	98.0%	1500	N/A	N/A	N/A	N/A	N/A	N/A
50% Ethanol	Yes	50.0%	30.0%	5000	60	40	N/A	1400	N/A	N/A
70% Ethanol	Yes	70.0%	51.0%	N/A	N/A	N/A	N/A	N/A	N/A	N/A
85% Ethanol	Yes	85.0%	50.0%	N/A	N/A	N/A	N/A	N/A	N/A	N/A
90% Ethanol	Yes	90.0%	81.0%	N/A	N/A	N/A	N/A	N/A	N/A	N/A
Absolute Ethanol	Yes	100.0%	92.0%	N/A	N/A	N/A	98.0%	1500	N/A	N/A
Ethanol	Yes	100.0%	51.0%	N/A	N/A	N/A	98.0%	1500	N/A	N/A
80/20 Ethanol / IPA	Yes	100.0%	81.0%	N/A	N/A	N/A	N/A	N/A	N/A	N/A
IPA	Yes	100.0%	90.0%	4500	N/A	N/A	95.0%	1500	N/A	N/A
Xylene	Yes	100.0%	68.0%	N/A	N/A	N/A	95.0%	1500	N/A	N/A

Legend

- 1 List of active reagent types
- 2 **Selected reagent type:**
Select by tapping in the name cell.
- 3 Density Meter check
- 4 **Defaults and concentrations:**
Tap cells to change.
- 5 **Remove reagent** button:
Move the selected reagent from the active to the dormant list.

Legend

- 6 **Add reagent** button:
Bring dormant reagent onto the active list.
- 7 **Purity thresholds** and **Temperature thresholds** buttons to switch views.
- 8 **Final reagent thresholds:**
Tap cells to change.
- 9 **Reagent change thresholds:**
Tap cells to change.

Not all reagents are checked by the density meters. If there is **Yes** in the **DM** column for a reagent (see [Figure 5-2](#)), it will be checked by the density meters.

Figure 5-3: **Reagent Types** screen, temperature thresholds view, using recommended reagent types for xylene-free processing

The screenshot shows the 'REAGENT TYPES' screen with a table of reagents. The table has columns for Type, DM, Defaults (Conc.), and Max. temperatures (Ambient, Vacuum, Safe). The reagents listed are Formalin, 50% Ethanol, 70% Ethanol, 85% Ethanol, 90% Ethanol, Absolute Ethanol, Ethanol, 80/20 Ethanol / IPA, IPA, and Xylene. The 'DM' column indicates whether the reagent is checked by density meters. The 'Max. temperatures' column shows the maximum temperatures for ambient, vacuum, and safe conditions. The 'Conc.' column shows the default concentration. The 'Type' column shows the reagent name. The 'DM' column shows 'Yes' or 'No'. The 'Conc.' column shows the default concentration. The 'Max. temperatures' column shows the maximum temperatures for ambient, vacuum, and safe conditions.

Type	DM	Defaults	Max. temperatures		
		Conc.	Ambient	Vacuum	Safe
Formalin	No	100.0%	60 °C	60 °C	45 °C
50% Ethanol	Yes	50.0%	92 °C	63 °C	45 °C
70% Ethanol	Yes	70.0%	88 °C	59 °C	45 °C
85% Ethanol	Yes	85.0%	87 °C	55 °C	45 °C
90% Ethanol	Yes	90.0%	82 °C	54 °C	45 °C
Absolute Ethanol	Yes	100.0%	78 °C	51 °C	45 °C
Ethanol	Yes	100.0%	78 °C	51 °C	45 °C
80/20 Ethanol / IPA	Yes	100.0%	78 °C	51 °C	45 °C
IPA	Yes	100.0%	82 °C	55 °C	45 °C
Xylene	Yes	100.0%	138 °C	99 °C	45 °C

Callouts in the image:

- 1: Points to the temperature threshold columns (Ambient, Vacuum, Safe).
- 2: Points to the list of active reagent types.
- 3: Points to the selected reagent type (Formalin).
- 4: Points to the default concentration column.
- 5: Points to the 'Remove reagent' button.
- 6: Points to the 'Add reagent' button.
- 7: Points to the 'Purity thresholds' and 'Temperature thresholds' buttons.

Legend

- Max. temperature:**
Tap cells to change.
- List of active reagent types
- Selected reagent type
- Default concentrations:**
Tap cells to change.

Legend

- Remove reagent** button:
Move the selected reagent from the active to the dormant list.
- Add reagent** button:
Bring dormant reagent onto the active list.
- Purity thresholds** and **Temperature thresholds** buttons to switch views.

Supervisors can edit the default concentration, purity thresholds and temperature thresholds for all active reagent types.

5. Reagent Setup

You edit a type's attributes by tapping the appropriate table cell and then entering the required value using the on-screen keypad. You will need to enter your user name to save the changes. The attributes update immediately and are applied to all reagent stations and protocols that use the reagent type. The changes will not affect running protocols.



Note: User name is a unique identifier for each user. The user name entered here must match the user name created for you. Contact your Supervisor if you don't know or forgot your user name.



Note: Lowering temperature thresholds may make protocol steps invalid. You must lower the step temperature to comply with the new reagent threshold before you can load or run the protocol.

Leica Biosystems does not recommend that you lower reagent concentration thresholds. Raising thresholds can help to correct poor quality processing due to impure reagents.

If you no longer use a reagent in the active list, you can move it to the dormant list, thus keeping the active list as small and easy to manage as possible. Select the reagent type by tapping its name and then tap **Remove reagent**.

5.2.3 Adding, Hiding and Deleting Reagents

To add, hide or delete reagents, go to **Admin > Reagent Types**. The **Reagent Types** screen appears. Follow the appropriate section below.

5.2.3.1 To Add a Reagent

You can make a dormant reagent active and create a new reagent (that is, add a reagent that is not currently on the active list or dormant list of reagents).

1. Tap **Add reagent**.

A dialog box listing all reagent types, ordered by reagent group, appears (see [Figure 5-4](#)).

Figure 5-4: **Add reagent** dialog box

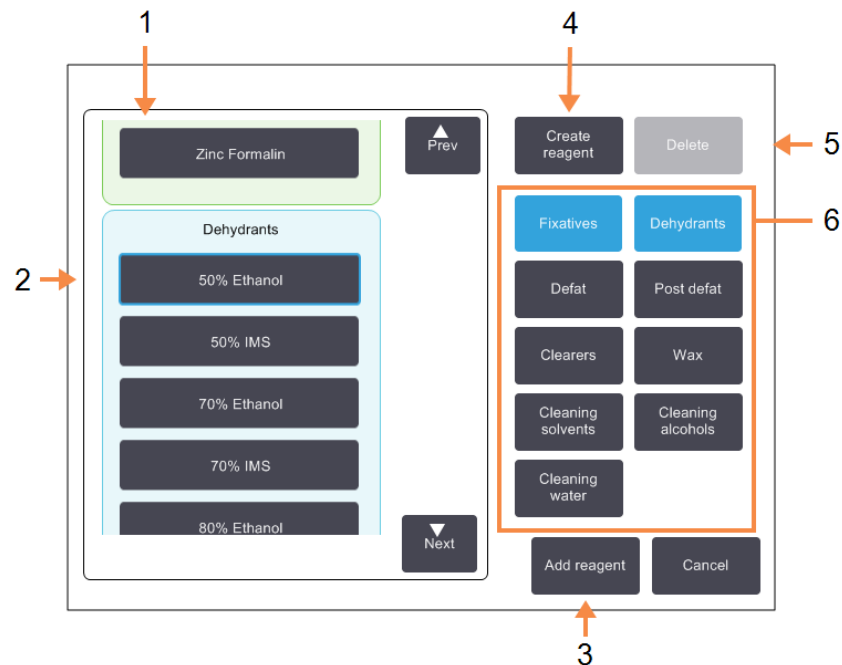

Legend

- 1 Complete list of reagent types filtered by reagent group (with buttons at right).
- 2 **Selected reagent type:**
Tap button to select.
- 3 **Add reagent:**
Transfer the selected reagent type from the dormant to the active list.

Legend

- 4 **Create reagent:**
Create a new reagent to add to the dormant list.
- 5 **Delete:**
Delete the selected reagent type (user defined protocols only).
- 6 **Reagent group filters:**
Tap to show just the reagent types (in the left of the dialog box) in the selected groups.

2. To add a dormant reagent to the active list:
 - i. Tap the button at the right of the screen that corresponds to the reagent's group (Fixatives, Dehydrants, etc.).
 - ii. Select the reagent in the list that appears at the left of the screen. (You may need to scroll down to find it.)
 - iii. Tap **Add reagent**.
The **Reagent Types** screen re-appears. The reagent you selected is now listed.
3. To add a new reagent type:
 - i. Tap **Create reagent**.
 - ii. Choose the group to which the new reagent belongs.
 - iii. Enter a unique name for the reagent and tap **Enter**.
The newly created reagent type is added to the list of dormant reagents.
 - v. If you want to make new reagent active, repeat from [step 2](#) above; otherwise tap **Cancel**. You are returned to the **Reagent Types** screen.

5.2.3.2 To Hide or Delete a Reagent

You can hide an active reagent by moving it to the dormant list. You can also and delete a reagent. A deleted reagent no longer appears on either the active or the dormant list. (Only user-defined reagents can be deleted.)

1. To hide a reagent:
 - i. Select it on the **Reagent Types** screen.
 - ii. Tap **Remove reagent**.
 - iii. Tap **OK** on the confirmation message.
If you want to make a dormant reagent active again, see [5.2.3.1 - To Add a Reagent](#).
2. To delete a reagent:
 - i. Tap **Add reagent**.
A dialog box listing all reagent types, ordered by reagent group, appears (see [Figure 5-4](#)).
 - iii. Tap the button at the right of the screen that corresponds to the reagent's group (Fixatives, Dehydrants, etc.).
 - iv. Select the reagent in the list that appears at the left of the screen. (You may need to scroll down to find it.)
 - v. Tap **Delete**.
If the **Delete** button is disabled, the reagent is pre-defined and cannot be deleted.
 - vii. Tap **OK** on the confirmation message.
 - viii. Tap **Cancel** to return to the **Reagent Types** screen.

5.3 Managing Reagent Stations

The PELORIS 3 has 20 stations: 16 reagent bottles and four wax chambers.

You must set the stations in the software to the reagent types loaded on the instrument. Once this is done, the system tracks each station's history (the number of runs and cassettes processed and number of days loaded on the instrument), current concentration, and, for wax chambers, the current temperature. See [5.1.1.3 - Stations](#) for further details.

Supervisors can set the reagent type for each station. They can also change concentration values if they know that actual concentrations are different from those recorded in the system. Both supervisors and operators can change station states if required. History details can only be viewed.

For the safe operation of the PELORIS 3, it is essential that there are bottles loaded into all bays in the reagent cabinet. If you do not wish to use a particular station, set its state to **Dry** and, for non-wax stations, insert an empty bottle into the station's reagent cabinet location.

The choice of which reagent types to load on the instrument, and how many bottles of each, is an important decision you must make. It will depend on the protocols you run. See [8.3 - Station Configurations](#) for configurations suitable for the default protocols.

This section contains the following subsections:

- [5.3.1 - Reagent Stations Screen](#)
- [5.3.2 - Setting Reagent Station Properties](#)

5.3.1 Reagent Stations Screen

To set up and manage reagent stations, and view a station’s history, go to **Reagents > Stations**. The **Reagent Stations** screen appears. This screen offers two views: one of the 16 reagent bottles (see [Figure 5-5](#)) and one of the four wax chambers (see [Figure 5-6](#)). Switch between views by tapping **Reagent bottles** or **Wax chambers**.

Figure 5-5: **Reagent stations** screen, reagent bottles view



Legend

- 1 **Type:**
Reagent type in station. Tap cell to change.
- 2 **Selected station:**
Tap in **Station** cell to select.
- 3 Hatched cell indicates change threshold exceeded. Out-of-threshold concentration value shown in red.
- 4 **Station:**
Station number with reagent group color code.

Legend

- 5 **Conc:**
Current concentration of reagent in station. Tap cell to change.
- 6 **Reagent bottles** and **Wax chambers** buttons to switch views.
- 7 **State:**
Current state of station. Tap cell to change.
- 8 **Since changed:**
The use history of each station - view only.

Figure 5-6: **Reagent stations** screen, wax chambers view

Station	Type	Conc.	Since changed			Temp.	State	Lot Number
			Cassettes	Cycles	Days			
w1	Wax	83.6%	750	5	49	65.0 °C	Full	None
w2	Wax	99.4%	300	2	0	65.0 °C	Full	None
w3	Wax	97.0%	750	5	49	65.0 °C	Full	None
w4	Wax	85.1%	1500	10	-68	65.0 °C	Full	None

Legend

- 1 **Type:**
Reagent type in station. Tap cell to change.
- 2 Hatched cell indicates change threshold exceeded. Out-of-threshold concentration value shown in red.
- 3 **Selected station:**
Tap in **Station** cell to select.
- 4 **Station:**
Station number with reagent group color code.
- 5 **Conc:**
Current concentration of reagent in station. Tap cell to change.

Legend

- 6 **Temp.:**
Current temperature in the wax chamber.
- 7 **Reagent bottles** and **Wax chambers** buttons to switch views.
- 8 **State:**
Current state of station. Tap cell to change.
- 9 **Since changed:**
The use history of each station - view only.

5.3.2 Setting Reagent Station Properties

5.3.2.1 Assigning New Reagents to Stations

If you change the type of reagent loaded in a station you must change the reagent type assigned to the station in the software. Note: you must be a supervisor to do this task, and there must not be a protocol running or loaded in either retort.



CAUTION: Altering reagent station configurations while protocols are running may cause abandoned protocols.

1. Remove the bottle with the reagent type (or drain the wax chamber) you are replacing.
2. Go to **Reagent > Stations** and tap in the station's **Type** cell. This opens the **Select a reagent** dialog screen (see [Figure 5-7](#) below).

Figure 5-7: Selecting a reagent

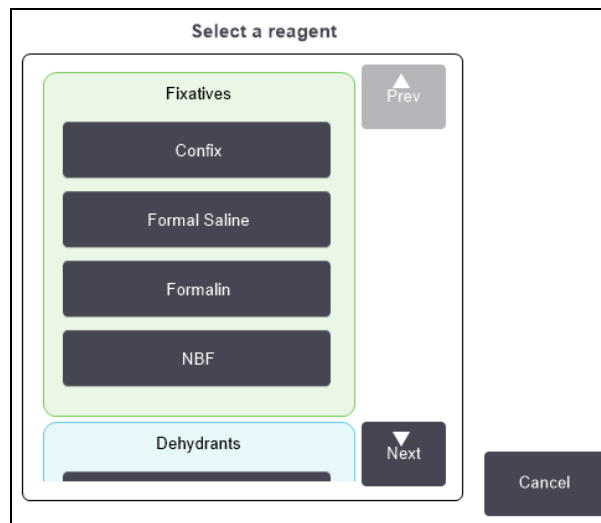

3. Select the new reagent type from the list.
The dialog box shows all the currently active reagent types. If the reagent is not listed, it may be on the dormant reagents list. See [5.2.3 - Adding, Hiding and Deleting Reagents](#) for instructions on how to activate a dormant reagent or add a new reagent.
4. When asked if you want to reset the properties of the selected station, tap **Yes**. This sets the history counters to zero and the station concentration to the default for the new reagent type.
5. Enter your user name. You must enter your user name for the first station you change but not for subsequent changes made at the same time. You can do this either by:
 - scanning your ID or
 - tapping the edit icon () and typing your user name with the on-screen keyboard.



Note: User name is a unique identifier for each user. The user name entered here must match the user name created for you. Contact your Supervisor if you don't know or forgot your user name.

6. Clean the bottle if necessary and fill with fresh reagent of the new type. Load the bottle back onto the instrument. (Alternatively, clean and fill the wax chamber.)

7. For a bottle:
 - i. In the **Inserted bottle configuration** dialog box, select the bottle in the table.
 - ii. Tap the **Changed** button.
 - iii. Enter the reagent concentration.
 - iv. Optionally enter the lot number details.
8. For a wax chamber:
 - i. Set the station state to **Full** on the **Reagent Stations** screen.
 - ii. Enter your user name.



Note: User name is a unique identifier for each user. The user name entered here must match the user name created for you. Contact your Supervisor if you don't know or forgot your user name.

When you change the reagent type for a station, you are always prompted to reset the station's concentration and history. If you select **No** you will retain the previous reagent's concentration and history. Use this option only if you are correcting a previous error in the identification of the reagent in the station and are not actually changing the station's contents.



WARNING: Always ensure that the reagents configured in the software are the actual reagents loaded on the instrument. A station containing different reagent could damage tissue samples.

5.3.2.2 Changing Reagent Concentration

You can set a station's calculated concentration value. Tap the station's **Conc.** cell. Enter the new concentration using the on-screen keypad. For the first change you make, you will need to enter your user name.



Note: User name is a unique identifier for each user. The user name entered here must match the user name created for you. Contact your Supervisor if you don't know or forgot your user name.

If a change is made to a reagent listed in [Table 5-2](#), the concentration of that reagent will be checked by the density meters when it is next used in a protocol run.



WARNING: Do not alter the concentration of a used reagent unless you are able to verify the actual concentration. If the concentration is incorrect, a reduction in tissue processing quality or damage to the tissue sample may result.

5.3.2.3 Setting Station States

All users can change station states. Allowable states are **Full**, **Empty**, **In use** and **Dry**. See [3.3.1 - Status Area](#) for detailed information on reagent station states.

You should not normally need to do this for reagent bottles. You update the bottle states when you remove and replace bottles, and then the software tracks the state automatically. Change bottle station states only if the wrong state is displayed or you want to make a full bottle unavailable for use (by setting it to **In use**).

For wax chambers you must change the station state as a normal part of wax replacement.

5. Reagent Setup

To change a station state:

1. Go to **Reagents > Stations**.
2. Tap the station's **State** cell.
3. Tap the appropriate icon on the dialog that appears (see [Figure 5-8](#)).

Figure 5-8: Station state dialog box for reagent stations (L) and wax chambers (R)

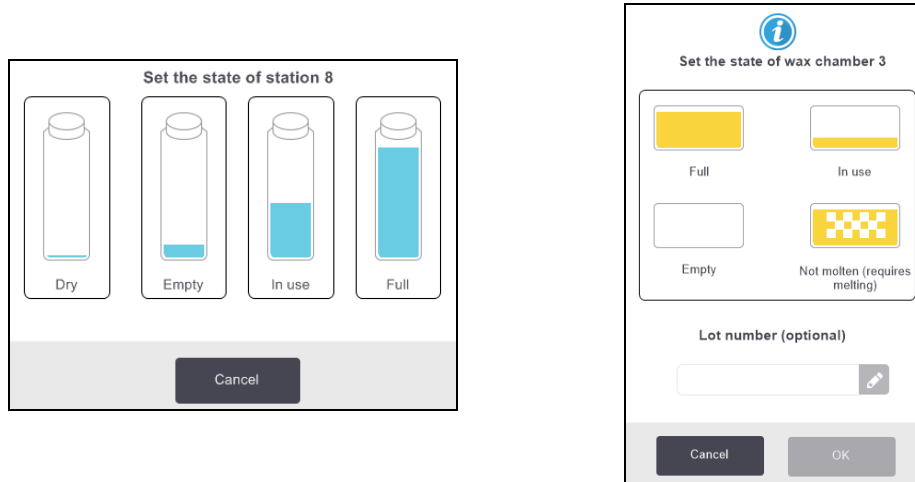

WARNING:

Ensure that you set the station state to the actual condition of the station. An incorrect reagent station state may cause fluid leaks or abandoned processing runs.

5.4 Replacing Reagents

When the system alerts you that a reagent should be changed, you should do so as soon as possible.

There are two ways to replace reagent in bottles:

- **Remote fill/drain** — using commands on the **Remote fill/drain** screen, pump the old reagent out and new reagent in. You don't need to remove the bottle from the reagent cabinet.
- **Manually** — remove the bottle from the reagent cabinet, drain and refill it, and then replace it in the cabinet.

For wax you must drain the chamber using the **Remote fill/drain** screen, fill the chamber manually, and then update the software.

This sections contains the following subsections:

- [5.4.1 - Remote Fill/Drain Screen](#)
- [5.4.2 - Remote Fill/Drain Connections](#)
- [5.4.3 - Replacing Reagent – Remote Fill and Drain](#)
- [5.4.4 - Replacing Reagent - Manually](#)
- [5.4.5 - Replacing Wax](#)
- [5.4.6 - Filling and Draining Retorts](#)

5.4.1 Remote Fill/Drain Screen

Use the **Remote fill/drain** screen (**Reagents > Remote Fill/Drain**) to fill and drain reagent bottles without removing them from the instrument. You use the same screen to drain the wax chambers. In a single operation, you can drain or fill a single station, or drain or fill a group of compatible stations. You can also fill and drain retorts from this screen. This enables you to recover from partially completed drain or fill operations.

The functions on the **Remote fill/drain** screen are available to all users: operators and supervisors.

[Figure 5-9](#) shows the **Remote fill/drain** screen with the main features described:

Figure 5-9: **Remote fill/drain** screen



Legend

- 1 **Fill to / Drain from bottles, Drain to waste, or Fill / Drain retort:**
Start fill or drain when appropriate station, remote source and retort are selected.
- 2 **Abandon:**
Stop the drain or fill.
- 3 **Wax waste:**
Select with a wax chamber to drain the chamber.
- 4 **Remote:**
Select with a retort and bottle to fill or drain the bottle.

Legend

- 5 **Retort A:**
Scheduled fill/drain operations for retort A.
- 6 **Retort B:**
Scheduled fill/drain operations for retort B.
- 7 **Wax System:**
Scheduled fill/drain operations for the wax chambers.

5.4.2 Remote Fill/Drain Connections

The remote fill/drain line and the wax drain outlet sit above the carbon filter in the reagent cabinet (see [Figure 5-11](#)). A protective flap covers the outlets. The wax waste line is heated to ensure that the wax does not solidify during the drain.

Figure 5-10: Remote fill/drain flap closed



Legend

- 1 Protective flap

Figure 5-11: Remote fill/drain flap open with reagent line (left) and wax waste line (right)

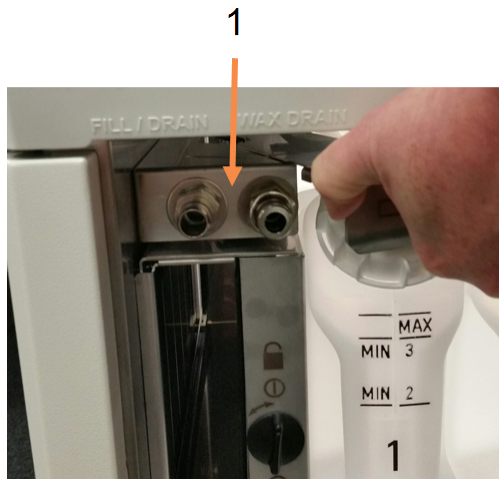

Legend

- 1 Fill and drain connectors

- Before draining a wax station, slide back the fill/drain flap and fit the wax waste hose to the wax waste line (right connection in [Figure 5-11](#)).

Ensure that:

- the wax waste hose drains into a suitable container and
- no part of the hose is submerged in the drained wax. This prevents wax from solidifying around the end of the hose and blocking it.

5. Reagent Setup

- Before filling or draining reagent bottles, connect the remote fill/drain hose (see [Figure 5-12](#)) to the remote fill/drain line (left connection in [Figure 5-11](#)). The hose has a push-fit coupling that ensures a secure connection to the line.

To fit the hose, slide back the fill/drain flap, and push the coupling onto the end of the line. To remove the hose, slide back the locking ring (item 1 in [Figure 5-12](#)) and pull the hose off the remote fill/drain line.

Figure 5-12: Remote fill/drain hose with locking ring (1)

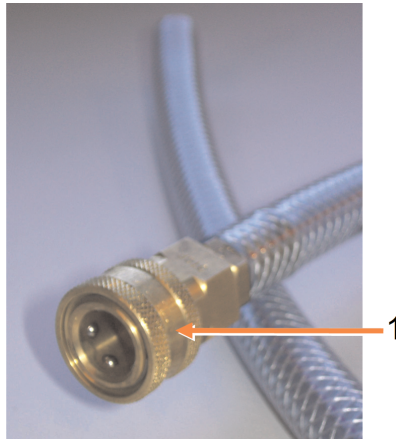

WARNING:

Always ensure that you fill from or drain to a large stable container. The fill/drain functions include a strong purge which may cause an unstable container to tip over and spill. The container must also be of sufficient volume to easily accommodate all of the drained fluid.

If you need to use a small container you must support the container and hose during the fill or drain.



WARNING:

Always use the hose supplied with the PELORIS 3.



WARNING:

Ensure you use the correct size wax drain hose to avoid wax leakage. Old and new instruments have different sized connectors.



WARNING:

To protect yourself from splashed reagent, always wear suitable eye protection and other protective clothing when handling reagents.

5.4.3 Replacing Reagent – Remote Fill and Drain

You can drain and then refill reagent bottles without removing the bottles from the instrument. The process drains each bottle to a retort and then drains the retort to the remote fill/drain line. The reverse procedure is used for the fill.

If you routinely use remote drain and fill, do not forget to check if bottles need cleaning. This should be done once a week.

Before you begin a remote fill or drain ensure there is a retort available:

- the retort must not have a protocol loaded or running
- the retort must be clean or empty and
- the retort residue (if any) must be compatible with the reagent in the bottle(s).

Drain

1. Connect the remote fill/drain hose and place the end in a suitable container (see [5.4.2 - Remote Fill/Drain Connections](#)).
2. From the **Remote fill/drain** screen (**Reagents > Remote Fill/Drain**), select the:
 - retort to use
 - **Remote** icon
 - bottle(s) to drain (multiple bottles must have reagent of the same type)

Figure 5-13: Remote fill/drain setup for draining bottles

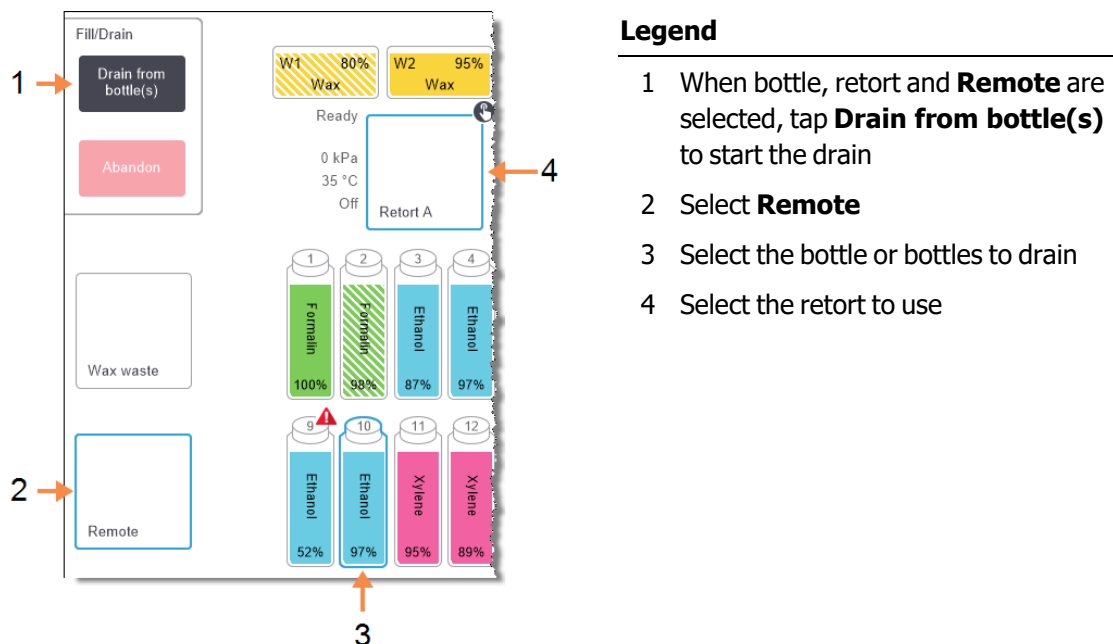

3. Tap **Drain from bottle(s)** to begin the drain.
4. When prompted, check that the retort lid is closed and the remote fill/drain hose is properly connected.
5. Tap **OK** to begin the drain.

5. Reagent Setup

6. Enter your user name. You can do this either by:
 - scanning your ID or
 - tapping the edit icon () and typing your user name with the on-screen keyboard.



Note: User name is a unique identifier for each user. The user name entered here must match the user name created for you. Contact your Supervisor if you don't know or forgot your user name.

The instrument will now drain the bottle(s) via the selected retort. You can monitor the drain progress in the status panel.

When the drain is finished, the retort state will be **Empty** and the bottle state **Dry**.



WARNING: Do not remove the remote fill/drain hose until the software indicates the process is complete and pressurized air has cleared the hose. A cessation of reagent flow is not an indication that the procedure is complete.

Fill

1. Place the hose into a container of fresh reagent.
The fresh reagent must be above 5 °C to ensure that the reagent sensors operate correctly.
2. From the **Remote fill/drain** screen, select:
 - The retort to use
 - The **Remote** icon
 - The bottle(s) to fill. (Multiple bottles must all be **Dry** and set to the same reagent type.)
Any bottle residue must be compatible with the new reagent.
3. Tap **Fill to bottle(s)** to begin filling.
4. When prompted, check that the retort lid is closed and the remote fill/drain hose is properly connected.
5. Tap **OK** to begin the fill.
A confirmation dialog box appears.

Figure 5-14: Confirmation dialog box showing the type, concentration and history for the new reagent

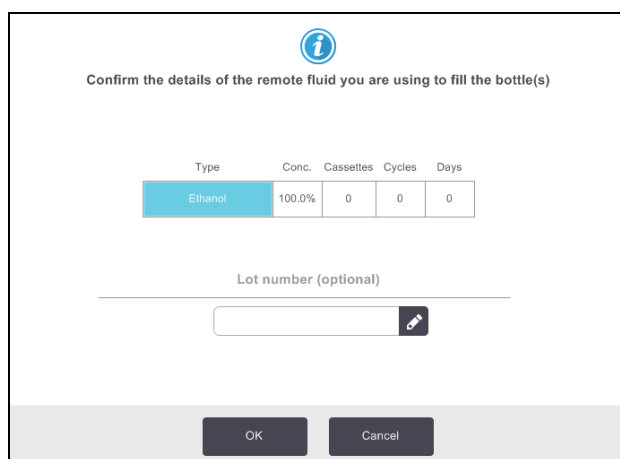

Confirm the details of the remote fluid you are using to fill the bottle(s)

Type	Conc.	Cassettes	Cycles	Days
Ethanol	100.0%	0	0	0

Lot number (optional)

OK Cancel

6. Confirm that the reagent type, concentration and history details are correct. If not, tap in the appropriate cell and change the value. You can also enter the reagent lot number details. If you set a new reagent type, the station must have already been set to that type (see [5.3.2.1 - Assigning New Reagents to Stations](#)). The reagent must be compatible with the retort and bottle residue.
7. Tap **OK** to start the fill.
8. Enter your user name. You can do this either by:
 - scanning your ID or
 - tapping the edit icon () and typing your user name with the on-screen keyboard.



Note: User name is a unique identifier for each user. The user name entered here must match the user name created for you. Contact your Supervisor if you don't know or forgot your user name.

9. The instrument will now fill the bottle(s) via the selected retort. The fill volume is determined by the reagent fill level set in the **Instrument settings** screen (see [6.3.3 - Instrument Settings](#)).

You can monitor the fill progress in the status panel.

A message will alert you when the fill is complete. The retort will be in an **Empty** state and the bottle in a **Full** state.



Note: At any time during the drain or fill you can tap the **Abandon** button to terminate all current and pending fill/drain operations.



Note: If you abandon a drain when both the retort and bottle are partially full, you must drain the retort back to the original bottle to continue. To drain the retort, deselect the **Remote** icon then tap the **Drain retort** button.



WARNING: Do not open a retort while it is being used for a remote fill or drain operation as the retort could be pressurized and may contain hot reagent and fumes. Allow the fill or drain to complete, or abandon the process before opening the retort.

5.4.3.1 Remote Fill and Drain Sequences

The following reagent sequences are recommended when filling and draining multiple bottles:

Order	Drain sequence	Fill sequence
1	Fixatives	Cleaning solvents
2	Cleaning alcohols	Clearers
3	Dehydrants	Defatting solvents
4	Defatting alcohols	Defatting alcohols
5	Defatting solvents	Cleaning alcohols
6	Cleaning solvents	Dehydrants
7	Clearers	Fixatives

5.4.4 Replacing Reagent - Manually

To replace a bottle manually, remove it from the reagent cabinet and dispose of the old reagent (following your laboratory's standard procedures). Clean the bottle if necessary, and then fill it with fresh reagent. Load it back into the reagent cabinet, making sure that it fits firmly into the connectors at the back of the cabinet.

When the bottle is reinserted, the **Select a bottle to update** dialog appears, showing the reagent type and concentration for the bottle when it was removed.

Now follow the process for recording what you did with the bottle (as shown in [Figure 5-15](#) below).

Figure 5-15: Recording the replacement of a reagent

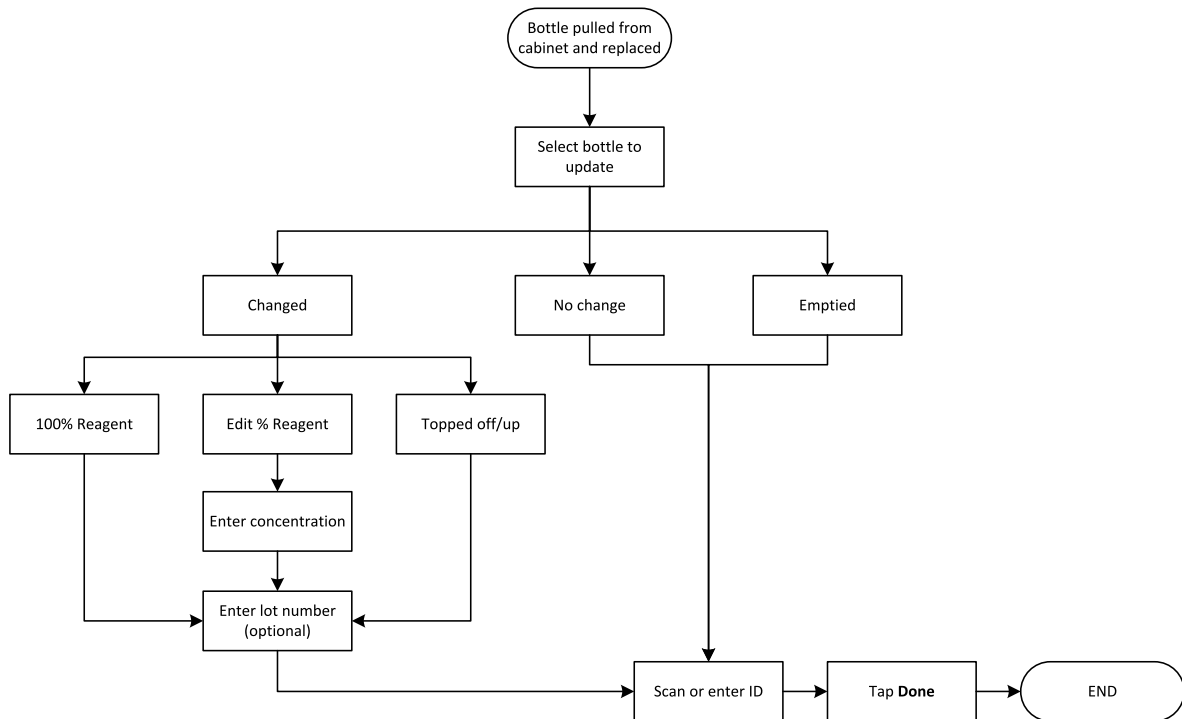

When you select a bottle to update, the options available are:

- **Changed** - select if you replaced the old reagent with fresh reagent, and then select either:
 - **100% Reagent** - select if you replaced the reagent with the same type, at 100% concentration.
 - **Edit % Reagent** - select if you replaced the reagent with the same type, but at a different concentration.
 - **Topped off/up** - select if you did not change all the reagent but added a small amount of fresh reagent of the same type to bring up its level in the bottle. (With this option the bottle state changes to **Full**. The concentration and history details do not change.)
- **No change** - select if you made no changes to the reagent in the bottle.
- **Emptied** - select if you emptied the bottle but did not refill it.



WARNING:

Always change reagents when prompted.
Always update station details correctly. Never update the details without replacing the reagent.
Failure to follow these directives can lead to tissue damage or loss.



WARNING: To avoid reagent spillage, ensure that caps are tightly closed and that the bottles are firmly plugged into their connectors at the back of the reagent cabinet.

5.4.5 Replacing Wax

Before you begin, ensure there is a retort available. Draining wax does not fill a retort, but it does use retort scheduling resources, so at least one retort must be available. The retort does not need to be clean.

The wax to be drained must be molten.

Drain

1. Connect the wax waste hose and place the end in a suitable container (see [5.4.2 - Remote Fill/Drain Connections](#)).
2. Go to **Reagents > Remote Fill/Drain** and select the:
 - wax stations to drain and
 - **Wax waste** icon.

Figure 5-16: Remote fill/drain setup for draining wax chambers

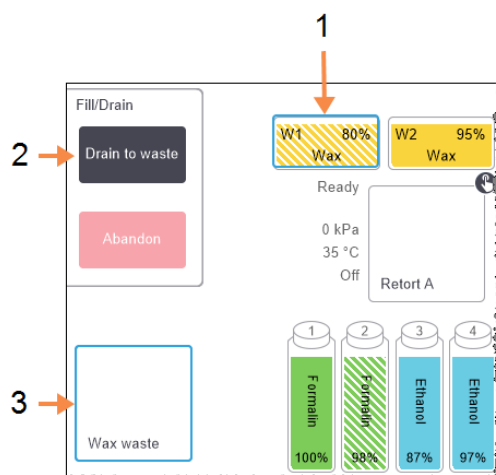

Legend

- 1 Select the wax chamber or chambers to drain.
- 2 When wax chamber and **Wax waste** icon are selected, tap **Drain to waste**.
- 3 Select **Wax waste**.

3. Tap **Drain to waste**.
4. A confirmation message appears asking you to check that the wax waste hose is properly connected and feeding into a suitable container.
5. Tap **OK** to begin the drain.

The instrument will now drain the chambers. You can monitor the progress in the status panel. Wax drains can take up to three minutes.

When the chambers are completely drained, a dialog will appear and the state of each drained chamber will be **Empty**. Do not remove the wax drain hose until the dialog confirms a successful drain. Refer to the warning messages below.



WARNING: The wax leaving the waste wax line will be hot and may cause burns. Make sure the wax drains to a suitable container and stand clear while it drains.

**WARNING:**

Do not remove the wax drain container or hose until the software indicates that the drain has completed. A cessation of wax flow is not an indication that the drain procedure is complete.

If no wax drains it is likely that the wax hose is blocked. If you remove a blocked hose before the drain is abandoned hot wax will spurt from the front of the instrument. Abandon the drain before removing the hose and melting the wax with hot water.

6. To stop wax solidifying in the drain hose, promptly remove the hose from the container holding the drained wax.
-



Note: At any time during the drain, you can tap **Abandon** to terminate all current and pending fill/drain operations.

Fill

1. If you are filling a wax chamber with molten wax, place the pin end of the LLS cleaning tool into the air vent at the rear of the wax chambers. This will help prevent wax from entering the vent during filling.

Figure 5-17: Wax bath air vent

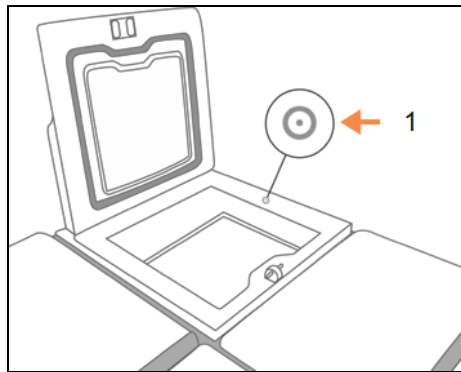

Legend

- 1 Air vent

2. Fill the wax chamber with molten or solid wax.
3. If you placed the LLS cleaning tool in the air vent, remove the tool.
4. Close the wax bath lid.
5. Go to **Reagents > Stations > Wax chambers**.

The row for the drained wax chamber shows the default concentration. It also shows the history values re-set to zero. The station state is **Dry**.

The reagent type is unchanged from the wax that you drained unless you changed the type assigned to the station after the drain.

6. Tap the **State** cell for the chamber. The following dialog box appears:

7. If you have added molten wax, select **Full**.

8. If using solid wax, select **Not molten (requires melting)**.

9. Optionally enter the lot number of the new wax.

10. Tap **OK**.

11. Enter your user name. You can do this either by:

- scanning your ID or
- tapping the edit icon () and typing your user name with the on-screen keyboard.



Note: User name is a unique identifier for each user. The user name entered here must match the user name created for you. Contact your Supervisor if you don't know or forgot your user name.

If you set the state to **Not molten (requires melting)**, a rapid wax heating process begins. You may need to add extra wax as it melts.

The station's state automatically changes to **Full** when the wax is ready to use.

5.4.6 Filling and Draining Retorts

The **Remote fill/drain** screen can also be used to drain or fill retorts. This is particularly useful in recovering from incomplete remote fill/drain operations. The retort fill and drain functions operate according to rules designed to avoid reagent contamination, reagent spills and reagent overheating. You can override some of these rules, but this might result in reduced reagent concentration.

You can also fill and drain retorts using the **Manual Operations** screen (see [6.1.1 - Manual Operations](#)).

The rules for manually filling and draining retorts are:

- The retort must be clean or empty before you commence a retort fill operation.
- If the retort is empty, the selected station must have compatible reagent (see [8.5 - Reagent Compatibility Tables](#)).
- You cannot fill a retort with a reagent that has a temperature threshold below the set retort temperature.
- When draining a retort, the reagent must return to its original station.
- When draining a retort, the station must have sufficient capacity for the retort contents.



Note: To avoid fluid spills, ensure that there is adequate station capacity before overriding insufficient capacity errors.

To fill or drain a retort:

1. Go to **Reagents > Remote fill/drain**.
2. Select the retort that is to be filled or drained.
3. Select the reagent station that is to fill the retort (or collect the retort's contents).
4. Tap the **Fill retort** or **Drain retort** button.
5. Enter your user name.



Note: User name is a unique identifier for each user. The user name entered here must match the user name created for you. Contact your Supervisor if you don't know or forgot your user name.

To stop the fill or drain at any stage, tap **Abandon**.



WARNING: Never fill a reagent station that has contents already in it. This may cause fluid spills.

6. Ancillary Settings & Operations

This chapter describes settings and operations not discussed elsewhere in this manual. It is organized by menu. The topics discussed are:

Reagents menu

- [6.1.1 - Manual Operations](#)

Admin menu

- [6.2.1 - Reports](#)
- [6.2.2 - Event Logs](#)
- [6.2.3 - Access Level](#)
- [6.2.4 - User Management](#)

Settings menu

- [6.3.1 - Service Settings](#)
- [6.3.2 - Reagent Management](#)
- [6.3.3 - Instrument Settings](#)
- [6.3.4 - Device Settings](#)
- [6.3.5 - Alarms](#)

6.1 Reagents Menu

You can manually control a number of the reagent-handling features of the PELORIS 3 from the **Manual Operations** screen.

6.1.1 Manual Operations

From the **Manual Operations** screen (**Reagents > Manual Operations**) you can manually control many aspects of the instrument. [Figure 6-1](#) illustrates the screen and explains what can be done on it. All users—operators and supervisors—can perform these functions.

Figure 6-1: **Manual Operations** screen

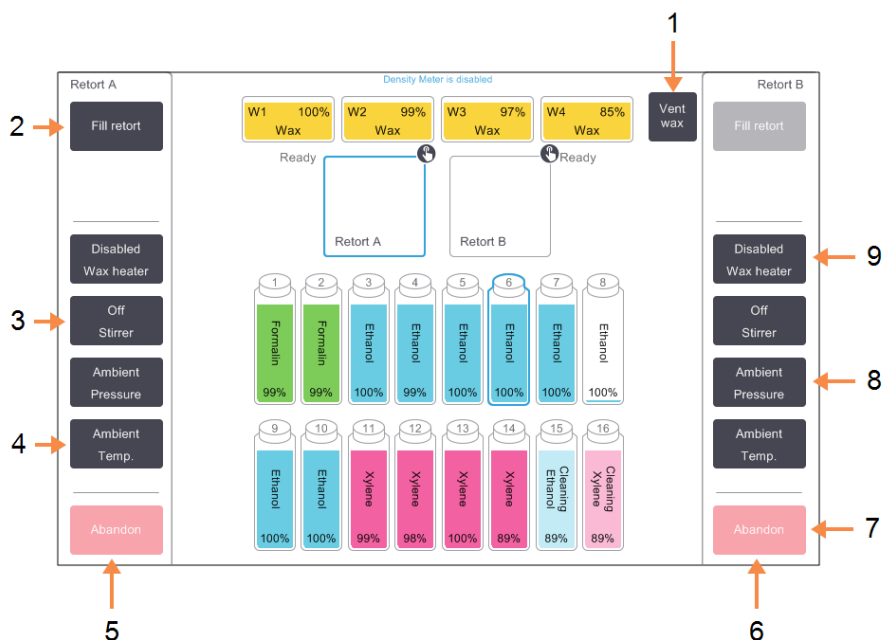

Legend

- 1 **Vent wax:**
Release pressure or vacuum in wax chambers.
- 2 **Fill / Drain retort:**
Fill or drain the retort from or to the selected station.
- 3 **Stirrer:**
Set the retort stirrer speed to high, medium, low or off.
- 4 **Temp.:**
Set the retort temperature.
- 5 Retort A controls

Legend

- 6 Retort B controls
- 7 **Abandon:**
Stop a fill or drain operation.
- 8 **Pressure:**
Set retort pressure - ambient, vacuum, pressure, or cycle pressure and vacuum.
- 9 **Wax heater:**
Turn on / off heaters for wax path.



- Note:** From the **Manual Operations** screen, you cannot:
- override a running protocol
 - fill or drain a retort that has a loaded protocol.

6.1.1.1 Retort Temperature Range

The retort temperature range is limited to the following values:

- **Reagent:** 35 °C – 78 °C maximum (restricted to a maximum of 65 °C when running tissue processing protocols).
- **Wax:** Wax melting point + 2 °C minimum to 85 °C maximum (restricted to 77 °C when running standard protocols).

View the current wax melting point on the **Settings > Reagent Management** screen.

Additional limitations may apply depending on the retort state and the reagent in the retort. You cannot raise the retort temperature above the safe temperature threshold of the reagent.

6.1.1.2 Wax Transfers

The wax path (comprising the wax valves and the transfer pipes) and the retort must be at the wax standby temperature before you attempt to fill a retort with wax. Each retort has a wax heater for achieving this.

1. Go to **Reagents > Manual Operations**.
2. Tap **Ambient Temp**.
3. Tap **Wax standby**.

Figure 6-2: Setting the retort temperature to the wax standby temperature

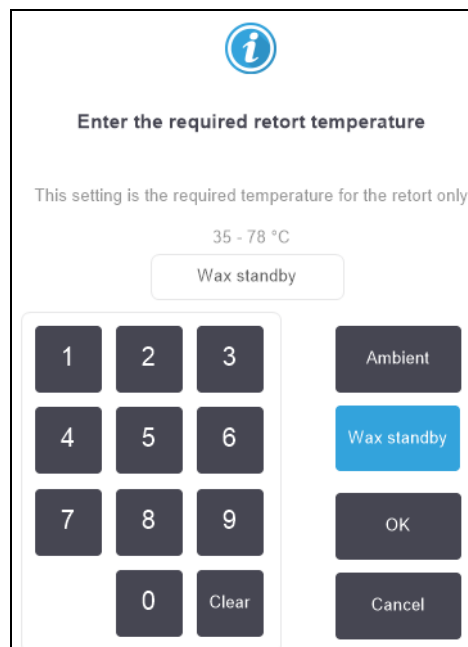

4. Tap **OK**.
5. Activate the wax heater by tapping the appropriate **Disabled Wax heater** button.
6. Click **OK** on the confirmation message.
Leave the heater on for at least five minutes.

7. Turn off the heater by tapping the appropriate **Enabled Wax heater** button.
8. Click **OK** on the confirmation message.

6.1.1.3 Filling and Draining Retorts

Fill (or drain) the retorts from (or to) a reagent station using commands on the **Manual Operations** screen. The rules, and procedures, for manually filling and draining retorts are the same as when you do this from the **Reagents > Remote Fill/Drain** screen. This is explained in [5.4.6 - Filling and Draining Retorts](#).

6.2 Admin Menu

You can run reports, view event logs, manage users, and change access-level settings from the **Admin** menu. See:

- [6.2.1 - Reports](#)
- [6.2.2 - Event Logs](#)
- [6.2.3 - Access Level](#)
- [6.2.4 - User Management](#)

6.2.1 Reports

Four reports are available from **Admin > Reports**:

- Run Details Report
- User Actions Report
- Protocol Usage Report
- Reagent Usage Report

6.2.1.1 Run Details Report

This report provides details of a particular protocol run. When selected, it first displays a list of all protocol runs, those in the previous month or those in the last 30 days (see [Figure 6-3](#)). Tap a button at the right of the screen to choose the duration you want.

Figure 6-3: **Protocol Runs** listing

END DATE	END TIME	RETORT	PROTOCOL NAME	# CASSETTES	STARTED BY
03-NOV-2016	07:39	A	Quick Clean	0	-
03-NOV-2016	01:29	A	Factory 1hr Xylene Standard	45	-
02-NOV-2016	23:26	A	Quick Clean	0	-
02-NOV-2016	22:39	A	Factory 1hr Xylene Standardhuj	23	-
02-NOV-2016	20:46	A	Quick Clean	0	-
02-NOV-2016	19:51	A	Factory 1hr Xylene Standard	55	-
02-NOV-2016	18:06	A	Quick Clean	0	-
29-OCT-2016	18:51	A	Quick Clean	0	-
29-OCT-2016	17:58	A	Factory 1hr Xylene Standard	150	-
27-OCT-2016	00:27	A	Quick Clean	0	-
25-OCT-2016	16:28	A	Factory 1hr Xylene Standard	50	-
24-OCT-2016	16:47	A	Quick Clean	0	-

From the protocol listing, you can display the details of one or more particular runs by selecting them and tapping **Generate**. The **Run Details** report appears, showing details of all the runs you selected (see [Figure 6-4](#)).

The details provided include the start and end time, user name, retort, number of cassettes, basket IDs, basket images (if the HistoCore I-Scan is in use), protocol steps, the station and reagent (with lot number if entered) for each step and the duration of the step. Any significant event that occurred during a protocol run is recorded.

Figure 6-4: **Run Details** report

Serial number: 45nnnnnn

1 Factory 1hr Xylene Standard Validated

RUN STARTED	RUN ENDED	USER	RETORT	# CASSETTES
29/10/2016 11:28	29/10/2016 17:58	-	A	150

Basket1	Basket2	Basket3
poi	uyt	tre

[Basket1 Image](#) [Basket2 Image](#) [Basket3 Image](#)

STEP	STATION	TYPE	LOT #	CONCENTRATION	DURATION (MINS)
1	2	Formalin	-	99.6%	1
2	9	Ethanol	-	71.4%	1
3	4	Ethanol	-	90.1%	1
4	5	Ethanol	rt2345	95.9%	1
5	10	Ethanol	-	97.8%	1
6	7	Ethanol	-	99.3%	1
7	6	Ethanol	-	99.8%	18

You can export run details by tapping **Export**. If no USB key is already inserted, you will be prompted to insert a USB key. An HTML file is generated. Tap **Done** when the transfer is complete. The HTML file can be saved to a computer and opened in a web browser.

Refer to [10.1 - Malware Detection](#) for additional information on malware scanning of the USB key used when exporting report files.

6.2.1.2 User Actions Report

This report lists the user actions that have been entered with a user name since the beginning of the month (see [Figure 6-5](#)). The details can be listed in time order or action order. The user name is only displayed if the report is run in supervisor mode.

Figure 6-5: **User Actions** report



DATE	TIME	USER	ACTION
03-NOV-2016	23:28	-	Started run - Factory 1hr Xylene Standard
03-NOV-2016	22:20	-	Started run - Quick Clean
03-NOV-2016	20:39	-	Started run - Factory 1hr Xylene Standardhuyj
03-NOV-2016	18:07	-	Maintenance: Clean retort and stirrer
03-NOV-2016	16:54	-	Changed Cleaning Xylene Bottle 15 from 92% to 100%
03-NOV-2016	15:20	-	Started run - Factory 1hr Xylene Standard
03-NOV-2016	09:13	-	Edited Bottle 6 Concentration value from 98.6% to 49.0%
03-NOV-2016	08:16	-	Started run - Factory 1hr Xylene Standardhuyj
03-NOV-2016	07:02	-	Started run - Quick Clean
03-NOV-2016	00:00	-	Started run - Factory 1hr Xylene Standard
02-NOV-2016	22:49	-	Started run - Quick Clean
02-NOV-2016	21:10	-	Started run - Factory 1hr Xylene Standardhuyj
02-NOV-2016	20:09	-	Started run - Quick Clean
02-NOV-2016	18:22	-	Started run - Factory 1hr Xylene Standard

You can export the user action details by tapping **Export**. If no USB key is already inserted, you will be prompted to insert a USB key. An HTML file is generated. Tap **Done** when the transfer is complete. The HTML file can be saved to a computer and opened in a web browser.

Refer to [10.1 - Malware Detection](#) for additional information on malware scanning of the USB key used when exporting report files.

6.2.1.3 Protocol Usage Report

This report lists the number of processing runs, cassettes and average number of cassettes per run for the last five years (see [Figure 6-6](#)). You can group the data by day, week or month.

Figure 6-6: **Protocol and Cassette** report

# RUNS	NOV-16	OCT-16	SEP-16	AUG-16	JUL-16	JUN-16	MAY-16
Factory 1hr Xylene Standard	7	12	0	0	0	0	0
Factory 1hr X... Standardhuyj	3	0	0	0	0	0	0
Total	10	12	0	0	0	0	0

# CASSETTES	NOV-16	OCT-16	SEP-16	AUG-16	JUL-16	JUN-16	MAY-16
Factory 1hr Xylene Standard	427	688	0	0	0	0	0
Factory 1hr X... Standardhuyj	71	0	0	0	0	0	0
Total	498	688	0	0	0	0	0

# CASSETTES PER RUN	NOV-16	OCT-16	SEP-16	AUG-16	JUL-16	JUN-16	MAY-16
Factory 1hr Xylene Standard	61	57	0	0	0	0	0
Factory 1hr X... Standardhuyj	23	0	0	0	0	0	0
Total	84	57	0	0	0	0	0

You can export the protocol usage details by tapping **Export**. If no USB key is already inserted, you will be prompted to insert a USB key. An Excel-compatible file is generated. Tap **Done** when the transfer is complete.

Refer to [10.1 - Malware Detection](#) for additional information on malware scanning of the USB key used when exporting report files.

6.2.1.4 Reagent Usage Report

This report lists the total volume of a reagent used by tracking when it is changed (see [Figure 6-7](#)). You can display the data by day, week or month.

Figure 6-7: **Reagent Change** report

REAGENT (Ltr)	NOV-16	OCT-16	SEP-16	AUG-16	JUL-16	JUN-16	MAY-16
Cleaning Ethanol	0	10.0	0	0	0	0	0
Cleaning Xylene	5.0	5.0	0	0	0	0	0
Ethanol	0	10.0	0	0	0	0	0
Formalin	0	5.0	0	0	0	0	0
Wax	20.0	0	0	0	0	0	0
Xylene	15.0	5.0	0	0	0	0	0

You can export the reagent usage details by tapping **Export**. If no USB key is already inserted, you will be prompted to insert a USB key. An Excel-compatible file is generated. Tap **Done** when the transfer is complete.

Refer to [10.1 - Malware Detection](#) for additional information on malware scanning of the USB key used when exporting report files.

6.2.2 Event Logs

The event log (**Admin > Event Logs**) displays a history of system events. You can sort the events by time or by frequency. You can also filter events by the type of event you want to view. You can add a message and save it as a user event, or retrieve information relevant to a particular event to send to your service representative.

Figure 6-8: Event log

EVENT LOG - BY TIME			
Code	Time	Description	
6	Wed 26 Oct 16 10:55	Power recovery routines completed	Prev
5	Wed 26 Oct 16 10:55	Power restored, Power failed at=Thu 27 Oct 11:23, Duration of power failure=00:00:00	Show by frequency ← 1
1402	Wed 14 Dec 16 22:31	Empty the condensate bottle.	On Filter ← 2
6	Wed 19 Oct 16 15:22	Power recovery routines completed	Create user event ← 3
5	Wed 19 Oct 16 15:22	Power restored, Power failed at=Mon 24 Oct 17:24, Duration of power failure=00:00:00	Clear logs
6007	Wed 19 Oct 16 19:49	Unvalidated protocol "Quick Clean" run	Incident report ← 4
1402	Wed 19 Oct 16 16:10	Empty the condensate bottle.	Next

Legend

- 1 Show by frequency / Show by time
- 2 Filter the logs in various ways

Legend

- 3 Create a user-entered log entry
- 4 Create an incident report for a selected log entry

In the show-by-time view, each event instance is listed with the most recent events at the top of the screen. Each event has the event type number, the event severity color code (see [6.2.2.1 - Event Severity](#)), the time the event occurred, and the event description.

In the show-by-frequency view, there is one row for each event type number, e.g. all the 1000 events—“protocol completed successfully”—are represented in one row. As well as the event number, severity color code and description, the number of instances of the event and the dates and times of the first and last instances of the event are shown.

The event log can only be cleared by service personnel.

Tap the **Show by time / Show by frequency** button to switch between the two views.

- Tap the **On Filter** button to open the **Configuration options ...** dialog box where you can select the types of events to view.

Select buttons in the **Retorts filters**, **Severity filters** and **Alarm filters** sections to see the associated types of events. You must select at least one button in each section to see any events. For example, if you select **Retort A** in **Retorts filters**, **Information** in **Severity filters** and **Non-alarmed events** in **Alarm filters** you will see all information events for Retort A that did not raise an alarm.

- The **Run log entry** button in the **Configuration options ...** dialog box is only enabled for service personnel.
- To create a user event, select **Create user event**. This opens the on-screen keyboard. Type in the information you want to record and tap **Enter** to add the message as an event. The event severity will be "Information".
- To create an incident report file for a specific event, select the event row in the table and tap **Incident report**.

6.2.2.1 Event Severity

There are three event severity levels and each has a color code:

Severity level	Description	Color code
Information	A normal event that requires a response (e.g. a protocol successfully completed) or an unusual event that has no detrimental effect (e.g. a user abandoned protocol).	Green
Warning	An error or potential error that does not stop processing, or a request for user action. For example, an out-of-threshold reagent used in a protocol.	Orange
Error	An error that causes an operation to abandon (e.g. because there is no station available), or makes part of the instrument (e.g. one retort) or the entire instrument unusable.	Red

6.2.3 Access Level

Use the **Access Level** screen (**Admin>Access Level**) to change the current access level and reset or change the Supervisor password.

Figure 6-9: Access Levels screen



Change the current access level

1. Tap the appropriate button - **Operator** or **Supervisor**.
2. If you are changing to the Supervisor access level, the onscreen keyboard will be displayed. Enter the Supervisor password and tap **Enter**.

Change the Supervisor Password

1. Tap the **Change password** button beside the **Supervisor** button.
2. Enter the current password and tap **Enter**.
3. Enter the new password and tap **Enter**.



Note: If the new password does not meet the criteria specified in [Password Rules](#) below, the following message will be displayed:
Password entered does not meet complexity criteria - refer to User Manual

Reset the Supervisor Password

If the Supervisor password is forgotten or lost it will need to be reset.

1. Tap the **Reset Password** button.
2. Contact your local technical support representative for a password reset code.
3. Enter the code provided.
4. Enter a new Supervisor password.
5. Enter the password again to confirm.



Note: If the passwords entered do not match, the following message is displayed:
Passwords entered do not match - please retry

Password Rules

Passwords must meet the following criteria:

- Must be at least 10 characters long.
- Must contain at least one character from at least three of the following groups:
 - Upper case letters of European languages
 - Lower case letters of European languages
 - Unicode characters (for languages that do not have upper/lower case characters)
 - Numeric values (0 – 9)
 - Non-alphanumeric characters (for example !, @, #, \$, %, ^ or &)

6.2.4 User Management

Supervisor can use the **User Management** screen under **Admin > User Management** to create new users, manage user details, import and export users, and generate a User Management Report.

Figure 6-10: User Management screen - Supervisor access

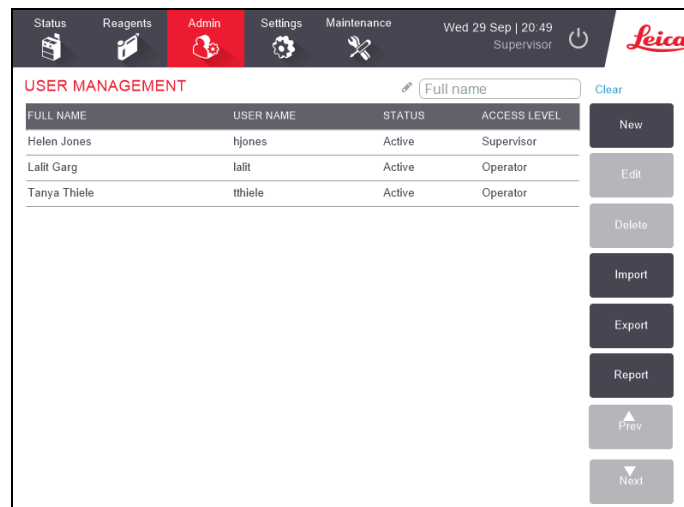

Note: The functions and user details within the **User Management** screen are only available to Supervisor users, to access them, change the current access level to Supervisor (refer to [Change the current access level](#)). [Figure 6-11](#) below shows the User Management screen when the access level is Operator.

Figure 6-11: User Management screen - Operator access

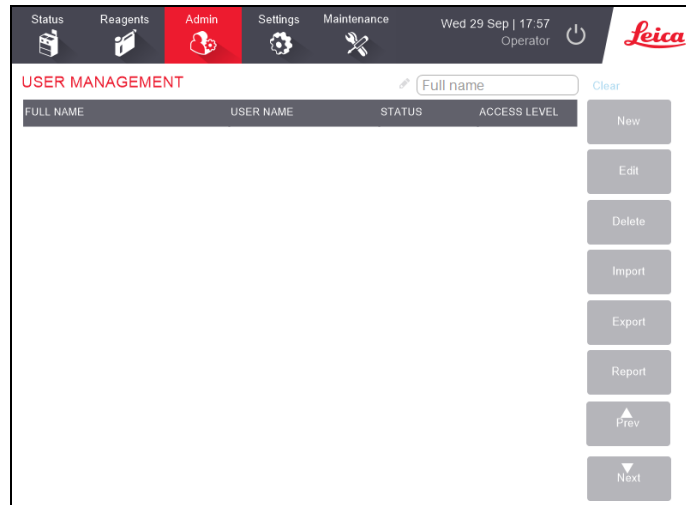

Create a New User

1. Tap on the **New** button.
2. Enter the details for the new user.

Figure 6-12: New User Details screen

Legend

- 1 **Full Name**
Full name of the user. 3-30 characters allowed.
- 2 **User Name**
Unique identifier for the user. 3-30 characters allowed. Cannot be the same as another user's user name.
- 3 **Status**
Active or Inactive. Tap the button to change the status.
- 4 **Access Level**
Operator or Supervisor. Tap the button to change the access level.

3. Tap **Save**



Note: To execute critical PELORIS workflows, users are prompted to enter their unique user name.

Edit User Details

1. Tap on the user to be edited to highlight it.
2. Tap the **Edit** button.
3. Edit the users details as required.
4. Tap **Save**.

Delete a User

1. Tap on the user to be deleted to highlight it.
2. Tap the **Delete** button.
The **Are you sure you want to delete...** message is displayed.
4. Tap **OK** to confirm.

Export/Import Users

Supervisors can export a list of all users from PELORIS 3 onto a USB key, and the same list of users can be imported into other PELORIS 3 instruments of the same or above software version.

1. Insert a USB drive into a USB port on the PELORIS 3 instrument.
2. Tap the **Export** button.
The Transfer Complete message is displayed.
4. Tap the **Done** button.
5. Remove the USB drive from the instrument.
6. Insert the same USB drive into another PELORIS 3 instrument of the same or above software version.
7. Go to **Admin > User Management** and tap the **Import** button.

The list of users from the initial instrument is now available on the second instrument.

User Management Report

The User Management Report displays a list of actions undertaken within the User Management screen, for example adding, editing and deleting users

1. Insert a USB drive into a USB port on the PELORIS 3 instrument.
2. Tap the **Report** button.

The report is saved on the USB drive with the name "UserManagementReport_<time>_<date>.html"

6.3 Settings Menu

The settings screens enable you to view instrument and software information, export and import files, alter certain hardware settings, and manage alarms.

There are five screens accessible from the **Settings** menu:

- [6.3.1 - Service Settings](#)
- [6.3.2 - Reagent Management](#)
- [6.3.3 - Instrument Settings](#)
- [6.3.4 - Device Settings](#)
- [6.3.5 - Alarms](#)

6.3.1 Service Settings

Go to **Settings > Service** to view instrument and software information.

Figure 6-13: **Service Settings** screen



The unit information area shows the instrument name, location, model and serial number. All values are read-only.

The software area displays the current software, FPGA firmware, CPLD firmware and translation version numbers. The software version may be needed when reporting a fault.

If the HistoCore I-Scan is connected, the scanner firmware version is displayed in the HistoCore I-Scan area.

6.3.1.1 File transfer

The file transfer options on the **Service Settings** screen enable you to copy protocol files, incidence reports and log files to a USB memory device. You can also import protocol files from a USB memory device.

Refer to [10.1 - Malware Detection](#) for additional information on malware scanning of the USB key used when exporting report files.

All users—operators and supervisors—can transfer files.

The basic workflow in transferring files is illustrated in [Figure 6-14](#).

Figure 6-14: File transfer workflows

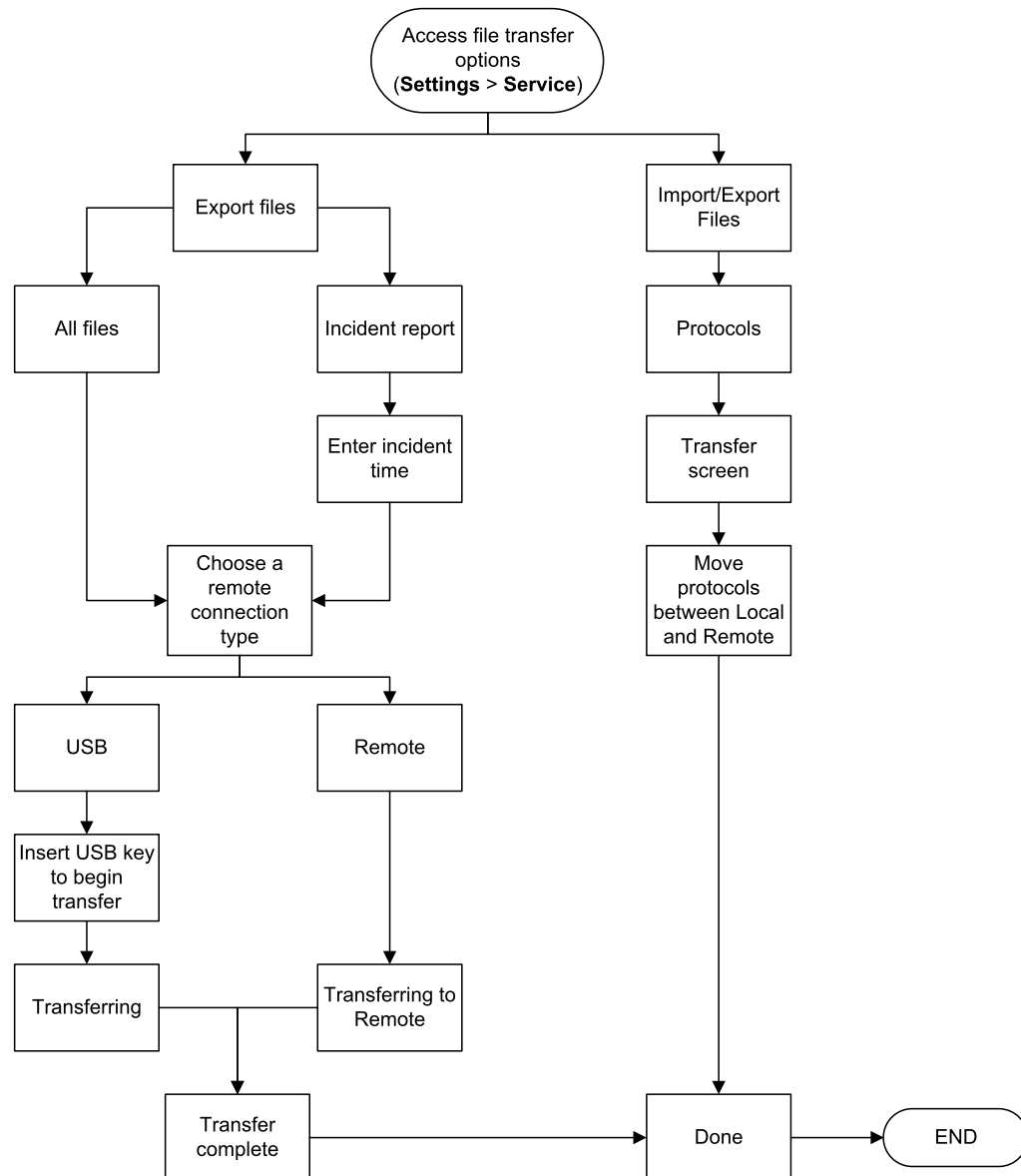

The available file transfer options are explained below:

- All files - select this option if you want to export all files from the PELORIS 3 to either a USB key or remote. (Only use the remote option if instructed by a service representative.)
- Incident report - select this option if you want to create and export an incident report from an event in the logs.
- Protocols - select this option if you want to move custom protocols between the PELORIS 3 and a USB device. The procedure is described in detail in the next section.

6.3.1.2 Transferring protocols

1. Place a USB memory stick into the USB port on the front of the instrument.
It is important that you insert the USB memory stick at the start of this procedure, otherwise its contents may fail to be recognized.
2. Tap **Settings > Service > Protocols**. A screen appears showing the local protocols (that is, the user-defined protocols on the instrument) and the remote protocols (that is, user-defined protocols at the root level of the USB memory stick, if there are any). Protocols stored in directories on the stick will be ignored.

Figure 6-15: Transferring protocols

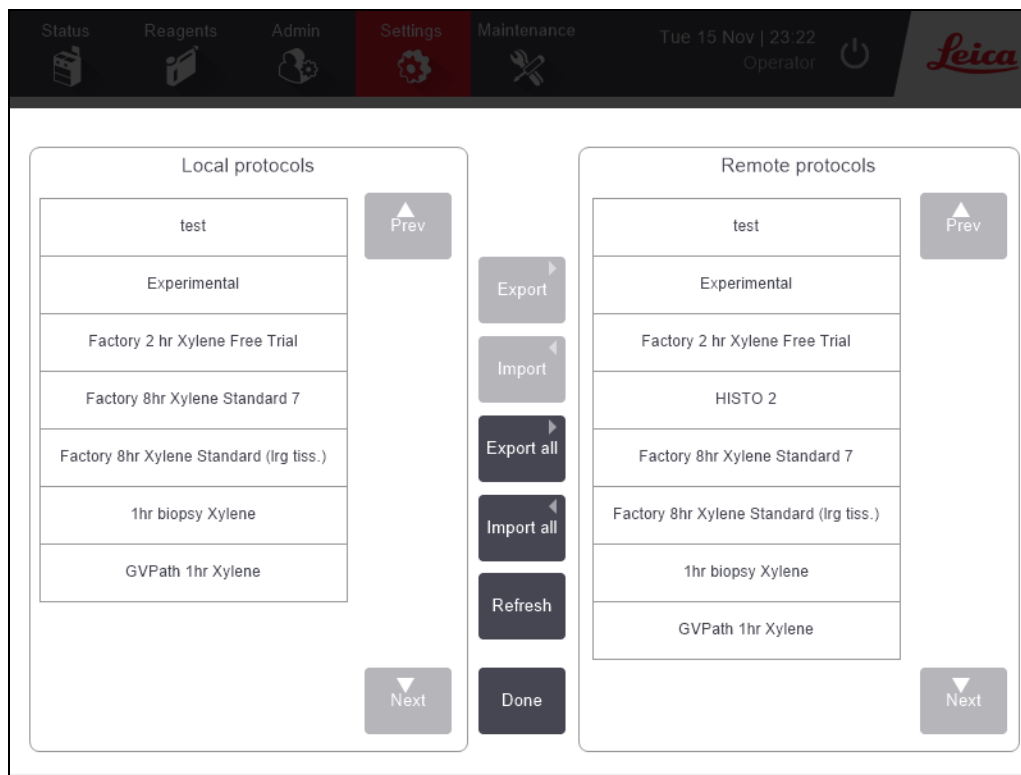

3. Tap **Refresh** to ensure that the protocol lists are current.
If you remove the USB memory stick before completing this procedure, make sure that you tap **Refresh** again when you reinsert it, or another memory stick.

If you tap **Refresh** before inserting a memory stick, the message that no remote device is available displayed with earlier version of PELORIS is no longer displayed.
4. To copy all user-defined protocols from the instrument to the memory stick, tap **Export all**.

5. To copy one user-defined protocol from the instrument to the memory stick, select it from the **Local protocols** list and tap **Export**.
6. To copy all the protocols listed on the memory stick to the instrument, tap **Import all**.
7. To copy one user-defined protocol from the memory stick to the instrument, select it from the **Remote protocols list** and tap **Import**.
8. Tap **Done** when you have finished.

6.3.2 Reagent Management

On the **Reagent Management** screen (**Settings > Reagent Management**) supervisors can:

- Set the default number of cassettes per run
- Set the default carryover setting
- Turn wax cleaning on and off
- Set wax standby and melting temperatures.

Figure 6-16: **Reagent Management** screen

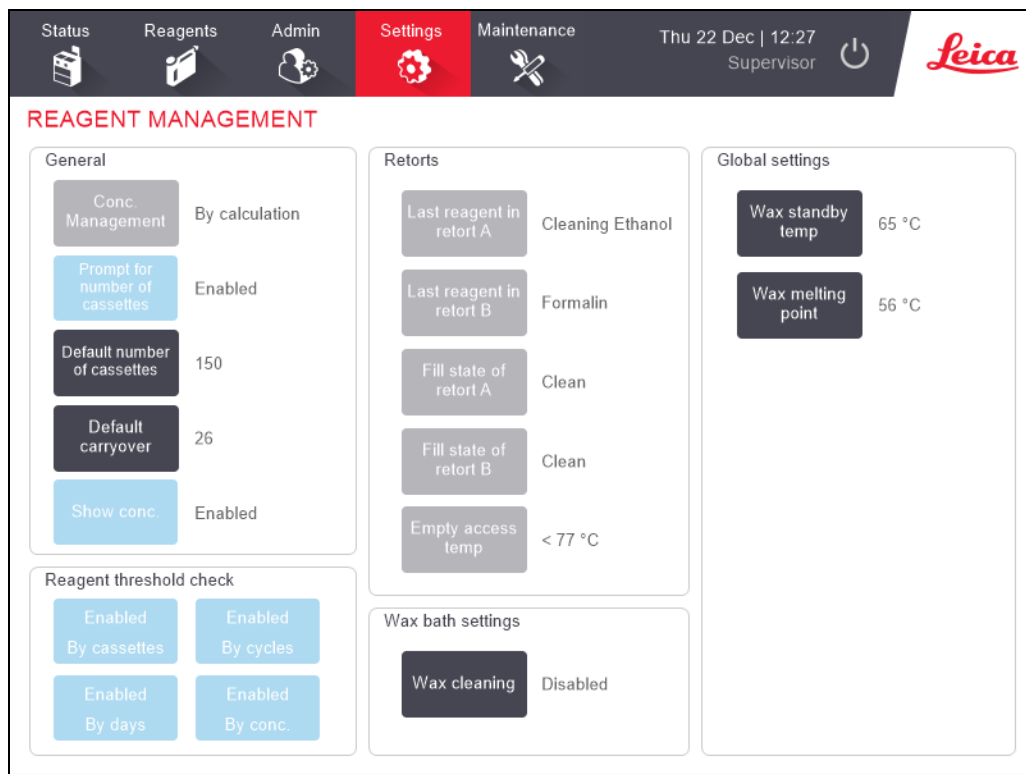

A range of other configuration settings can be viewed but not changed. Contact customer support to change any of these. The screen also displays the state of each retort and the last reagent in each retort.

Controls on the **Reagent Management** screen are described below, grouped by section.

6.3.2.1 General

- **Conc. Management** - (view only): the method the system uses to assign concentration values to reagent bottles (see [5.1.2 - Concentration Management](#)).
- **Prompt for number of cassettes** - (view only): with the default setting (**Enabled**) PELORIS 3 prompts you to enter the number of cassettes before each run. When the function is disabled, the system assumes that each run processes the default number of cassettes (see below).
- **Default number of cassettes** - set the default number of cassettes for each processing run. If **Prompt for number of cassettes** is enabled, the prompt dialog box opens before each run showing this number of cassettes. You can accept or change the number. If **Prompt for number of cassettes** is disabled, the system uses the number of cassettes entered here for all processing runs. In this case be sure to enter an accurate average value. The number is used by the reagent management system to calculate reagent concentrations.
- **Default carryover**- the default carryover setting used for new protocols (see [4.1.5 - Carryover Setting](#)).
- **Show conc.** - (view only): hides or shows the current wax and bottle concentrations on the **Status** screen.

6.3.2.2 Reagent Threshold Check

The four buttons in the **Reagent threshold check** section of the **Reagent Management** screen show which types of reagent thresholds the system is using (see [5.1.3 - Thresholds](#)). By default, all four threshold types are enabled. Contact your customer support representative to change any of these settings.

- **By cassettes** - the system tracks the number of cassettes processed by the reagent in each station. If the reagent type has a cassette threshold set, you are alerted when the station goes beyond that threshold.
- **By cycles** - the system tracks the number of processing runs performed by the reagent in each station. If the reagent type has a cycle threshold set, you are alerted when the station goes beyond this threshold.
- **By days** - the system tracks the number of days the reagent in each station has been loaded. If the reagent type has a days threshold set, you are alerted when the station goes beyond that threshold.
- **By conc.** - the system tracks the concentration of reagent in each station. If the reagent type has a concentration threshold set, you are alerted when the station goes beyond this threshold.

6.3.2.3 Retorts

The **Retorts** section of the **Reagent Management** screen shows the state of, and last reagent used in, each retort. It also shows the empty access temperature (that is, the temperature up to which it is safe to open empty retorts). The system warns you if you begin an action that requires you to open a retort when the temperature inside it exceeds this value.

6.3.2.4 Wax Bath Settings

Turn wax cleaning on and off with the **Wax cleaning** button on the **Reagent Management** screen. The wax cleaning function improves the quality of the wax by periodically evacuating the wax bath (for approximately 30 seconds) to draw off any contaminants. You may need to periodically add small amounts of wax to replace solvents that have been removed.

- Enable wax cleaning for protocols that use xylene and/or IPA.
- Disable wax cleaning for protocols that use xylene or IPA substitutes, as these clearers are not efficiently removed by the evacuation process.

By removing contaminants, wax cleaning increases wax concentrations. The system automatically updates the concentration of each wax station after each wax cleaning cycle.



Note: Wax cleaning can delay the start of a protocol or other action by up to 30 seconds.

6.3.2.5 Global Settings

Set the wax melting and wax standby temperatures in the **Global settings** section of the **Reagent Management** screen.

- The wax standby temperature is the temperature the instrument heats the wax to in the wax stations. The default temperature is 65 °C.
- The wax melting point is the temperature at which the instrument considers the wax molten. The default temperature is 56 °C.

6.3.3 Instrument Settings

Use the **Instrument Settings** screen (**Settings > Instrument**) to configure the carbon filter age and threshold, the date and time display, reagent fill levels and manual operation manual drain drip time. Supervisor access is required for all operations except the time format configuration.

You can also close down the instrument from this screen. Other settings on the **Instrument settings** screen can be viewed but can only be changed by a service representative.

Figure 6-17: **Instrument Settings** screen - Supervisor access

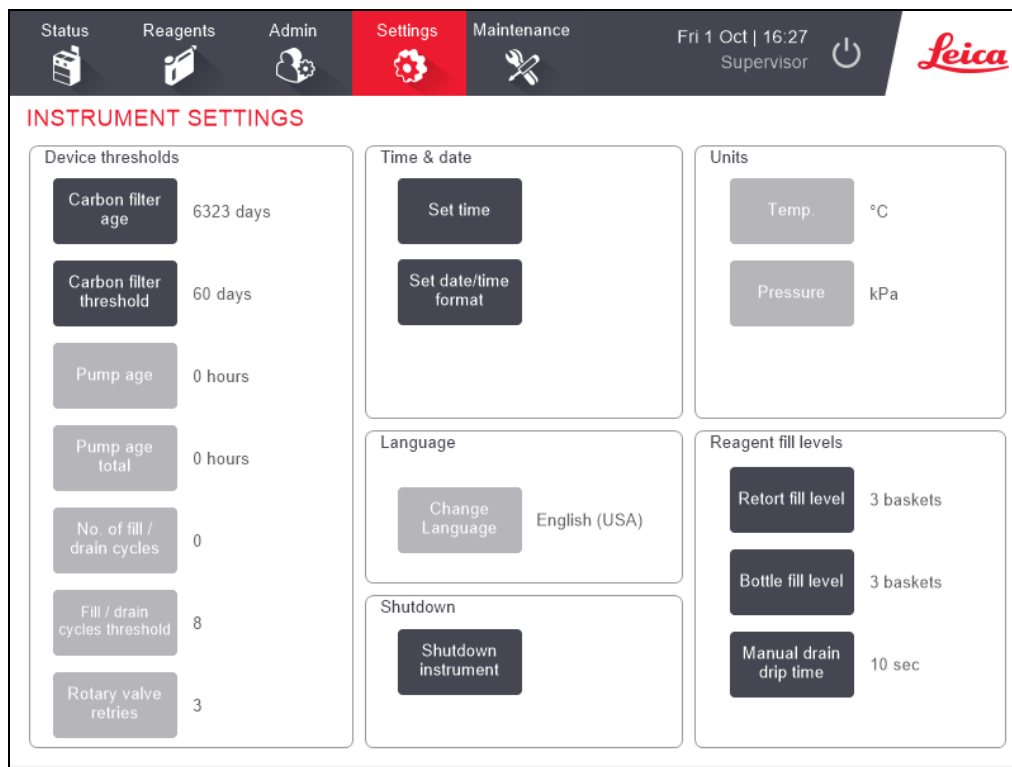

6.3.3.1 Carbon Filter Settings

Tap the **Carbon filter age** button to reset the age of the carbon filter to zero days. You should do this when replacing the carbon filter so that the PELORIS 3 can track the filter's age and provide an accurate warning when it exceeds its age threshold.

Tap the **Carbon filter threshold** button to set the number of days a filter can be used before it should be replaced. The correct threshold value depends on the average number of protocols you run each day and the type of reagents used. We recommend an initial threshold of 60 days with adjustments only if you are sure the carbon filter is becoming saturated earlier, or is still in good condition after this time.

If you are using an external vapor removal system, set the carbon filter threshold to either:

- The inspection interval for the external system
- The maximum value (1000) to limit the number of unwanted warnings
- Overridden (contact your service representative to arrange this setting)

See [2.8 - External Vapor Removal Systems](#) for more information.

6.3.3.2 Time and Date

Only supervisors can change the system time. All users can choose from three date-and-time formats (shortened, normal and extended).

- To change the system time, tap **Set time**, tap the **Up** and **Down** buttons until the correct time is reached, and then tap **Done**.
- To change time and date formats, tap **Set date/time format** and then the **Modify** button for a format you want to change. Select the required format. Modify other formats as required and then tap **Done**.

6.3.3.3 Instrument Shutdown

Tap **Shutdown instrument** to turn off the instrument in an orderly manner. When the touch-screen goes blank, turn off the red power button.

6.3.3.4 Reagent Fill Levels

The reagent fill levels determine the volume used to fill a retort and the reagent volume needed for a station to have a full state. You configure the instrument to fill the retorts with sufficient reagent to process either two or three cassette baskets. If the retorts are set for three baskets, the bottle fill level must also be three baskets. This is to ensure that there is sufficient reagent to fill the retorts.

Only supervisors can change fill levels.

- To set the retort fill level, tap the **Retort fill level** button and select two or three baskets.
- To set the reagent station fill level, tap the **Bottle fill level** button and select two or three baskets.



Note: If you increase the fill volume, you must visually check each reagent station to ensure that it holds sufficient reagent. A protocol may be abandoned if a station does not hold sufficient reagent.

6.3.3.5 Manual Drain Drip Time

Supervisors can change the drip time for manual drain operations. The drip time is the time the system waits for reagents to drip from cassettes and retort walls before completing the drain operation.

Tap the **Manual drain drip time** button, enter the required number of seconds and tap **OK**.

6.3.3.6 Language and Unit Settings

You can view, but not change, the instrument's language and units settings. Contact your service representative to change either setting.

6.3.4 Device Settings

The **Device Settings** screen (**Settings > Device**) enables you to control display settings and lock the screen for cleaning. Supervisors can configure instrument sounds, enable or disable power-off alarms for the external alarm connectors, enable or disable the use of the HistoCore I-Scan, and lock the monitor screen for cleaning and maintenance.

Figure 6-18: **Device Settings** screen

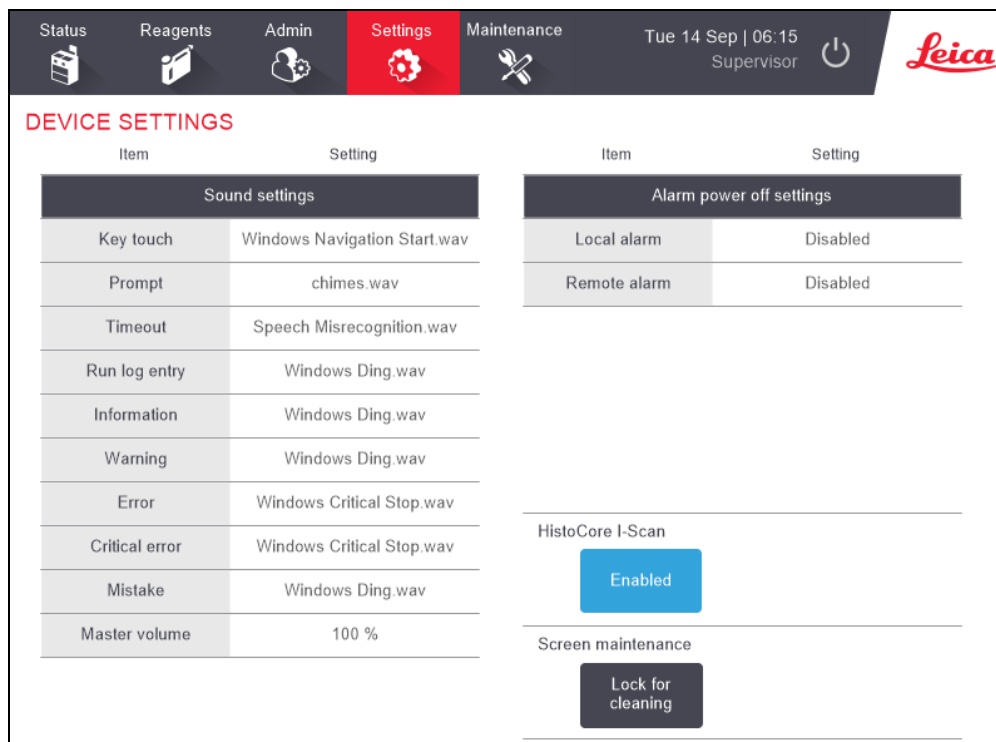

6.3.4.1 Sound Settings

Supervisors can select from a range of sounds that are to be emitted for various types of event, or to silence these sounds. For example, a sound can be set for key touches on the touchscreen, or to accompany a prompt dialog box or warning. There is also volume control for all instrument sounds.

- To change the sound associated with an event type, tap the cell beside the event type in the **Sound Settings** table. Select a sound file in the **Select a sound from the following list** dialog box and tap **OK**. Select **<no sound>** to have no sound for the event type.

To hear a sound in the **Select a sound from the following list**, select it and tap **Play**.

- To change sound volume tap the cell beside **Master volume** in the **Sound settings** table. Set a value between 100 (loudest) and 0 (silent).

6.3.4.2 Alarm Power Off Settings

Use the alarm power off settings to control the behavior of the external LOCAL ALARM and REMOTE ALARM (see [2.9 - Alarm Connections](#)) in the event of a power failure. If the power-off state is set to **Enabled**, the alarm will activate (sound) if there is a power failure.

To change the setting, tap the cell beside **Local alarm** or **Remote alarm** in the **Alarm power off settings** table and then tap **OK** in the dialog box.

You require supervisor-level access to alter these settings.

6.3.4.3 Screen maintenance

To lock the screen, tap the **Lock for cleaning** button. The **Clean screen** dialog box opens. You can safely clean the screen without accidentally selecting any controls while this dialog box is open.

When finished cleaning, tap the **Clean screen** buttons in the correct order. This unlocks the screen and returns it to normal operation.

6.3.5 Alarms

PELORIS 3 uses alarms to alert users when events of certain types occur. These events are mostly for error conditions that require quick intervention, but alarms also activate for some normal conditions that it is useful to be informed about, such as when a protocol has finished.

When an alarm activates, the associated event is displayed on the **Alarms** screen (**Settings > Alarms**) and one or more of the following occurs, depending on how the alarm is configured:

- the instrument's internal alarm sounds
- the LOCAL ALARM connection turns on, triggering any connected alarm (see [2.9 - Alarm Connections](#))
- the REMOTE ALARM connection turns on, triggering any connected alarm (see [2.9 - Alarm Connections](#))
- a dialog box opens in the software displaying the alarm message.

Active alarms can be cleared (i.e. turned off) on the **Alarms** screen. If an alarm has triggered a message, it can also be cleared from the message.

Alarms can also be silenced from the **Alarms** screen and alarm messages. This turns off the instrument's internal alarm and closes the message, but the local and remote alarms remain on until the alarm is cleared. This allows an operator at the instrument to continue to use the software without the alarm sounding, while the external alarms continue in order to bring assistance.

The internal, local and remote alarms have one of two on states: **Momentary** triggers the alarm once only, while **Repetitive** continues the alarm until it is cleared (or, for the internal alarm only, silenced).

- To clear or silence an active alarm, tap the **Activated** cell in the **Alarms** screen for the alarm event and tap **Off** or **Silenced**.
Off stops all alarm outputs and removes the event from the **Alarms** screen.
Silenced silences the internal alarm, but the alarm is still active on the **Alarms** screen.
- To clear or silence an alarm in an alarm message, select the event in the table of alarm events (there may be more than one alarm active at once) and tap **Clear** or **Silence**.
Clear stops all alarm outputs and removes the event from the message (and **Alarms** screen). The message closes if there is only one alarm event.

Silence silences the internal alarm, but the alarm is still active on the **Alarms** screen. The message closes if there is only one alarm event.

If there is more than one alarm event in a message, you can tap **Clear all** or **Silence all** to clear or silence all the alarms at once.

7. Cleaning and Maintenance

Follow the maintenance and cleaning instructions in this chapter to keep your PELORIS 3 processor in good working order. This will help ensure quality processing at all times, and avoid unnecessary service calls.

Ensure that the PELORIS 3 is left on at all times, even when not in operation. This keeps wax molten and allows preventative maintenance routines controlled by the software to be carried out.

Leica Biosystems recommends a preventative maintenance call either once a year or when the instrument flags that the pump diaphragm has exceeded 1000 hours (message code 1336), whichever occurs first. Contact your service representative to organize a call.



WARNING: Always wear gloves and other suitable protective clothing when cleaning the instrument.



CAUTION: Do not use any cleaning materials or methods other than the ones described in this chapter. The use of other materials and methods may damage the instrument.

This chapter has the following sections:

- [7.1 - Cleaning and Maintenance Tools](#)
- [7.2 - Maintenance Screen](#)
- [7.3 - Cleaning and Maintenance Schedule](#)

7.1 Cleaning and Maintenance Tools

The PELORIS 3 cleaning and maintenance tools are stored on the back of the touch-screen (see [Figure 7-1](#)). The tools are:

- [7.1.1 - Wax scraper](#)
- [7.1.2 - LLS cleaning tool and wax vent plug](#)

Figure 7-1: Position of the cleaning tools



7.1.1 Wax scraper

(Part number S45.2000)

The wax scraper ([Figure 7-2](#)) can be used to scrape wax from around the seals of a wax bath lid (as shown in [Figure 7-3](#)) and from the top of a wax bath.

Figure 7-2: Wax scraper



Figure 7-3: Using the wax scraper



7.1.2 LLS cleaning tool and wax vent plug

(Part number S45.2001)

The LLS cleaning tool has been specially designed to cover an LLS. Dampen a clean cloth with a solution of 70% alcohol and twist the cloth around an LLS using the LLS cleaning tool (see [Figure 7-4](#)). For particularly dirty sensors, use a solution of 6% acetic acid instead of the alcohol.

Figure 7-4: Using the LLS cleaning tool



Protruding from the other end of the LLS cleaning tool is a lug that can be inserted into the wax bath air vent. This will help prevent wax falling into the instrument when you are cleaning around the top surface of the wax baths.

7.2 Maintenance Screen

The **Maintenance** screen provides a way to record the activity and timing of routine maintenance functions.

Figure 7-5: The Maintenance screen

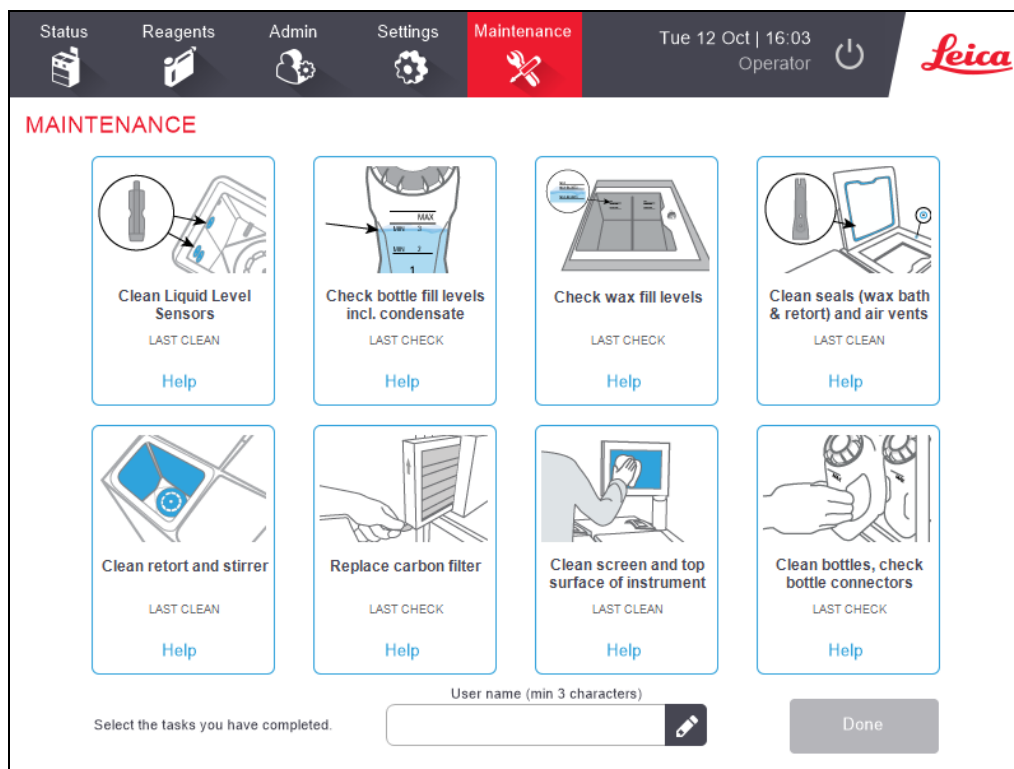

The eight panels on the **Maintenance** screen consist of:

- an image of the instrument showing what needs to be done (sometimes highlighted in blue)
- a title
- an indicator of when the item was last checked or cleaned, and the operator who did it
- a link to context-sensitive help instructions.

To record a maintenance task:

- tap the panel for the maintenance task you have done or are about to do
- enter your user name



Note: User name is a unique identifier for each user. The user name entered here must match the user name created for you. Contact your Supervisor if you don't know or forgot your user name.

- tap **Done**.

Recorded maintenance tasks can be viewed in the **User Actions** report.

7.3 Cleaning and Maintenance Schedule

See the list below for regular cleaning and maintenance tasks and how often they should be done.

Refer to [7.3.5 - PELORIS 3 User Maintenance Chart](#) for a weekly maintenance and cleaning checklist that can be printed to use as a record of maintenance tasks. Initial the relevant cells in the table as tasks are carried out.

7.3.1 Daily

- [7.3.6.1 - Clean Lids and Seals](#)
- [7.3.6.2 - Clean Retorts and Liquid Level Sensors](#)
- [7.3.6.3 - Check Bottle Fill Levels \(including Condensate Bottle\)](#)
- [7.3.6.4 - Check Wax Fill Levels](#)
- [7.3.6.5 - Clean Touch-Screen and Top Surface](#)

7.3.2 Weekly

- [7.3.7.1 - Empty Condensate Bottle](#)
- [7.3.7.2 - Clean Reagent Bottles and Check Bottle Connectors](#)
- [7.3.7.3 - Check Wax Baths](#)
- [7.3.7.4 - Clean Exterior Surfaces](#)

7.3.3 60–90 Days

- [7.3.8 - 60–90 Days](#)
- [7.3.8.2 - Check Lid Seals](#)

7.3.4 As Required

- [7.3.9 - Retort Acid Clean](#)

7.3.5 PELORIS 3 User Maintenance Chart

Week:	Serial No:													
	Mon		Tues		Wed		Thurs		Fri		Sat		Sun	
Date:														
Daily Tasks														
Clean lids and seals														
Clean retorts														
Clean liquid level sensors														
Check reagent levels	Initial	OK/ T/C	Initial	OK/ T/C	Initial	OK/ T/C	Initial	OK/ T/C	Initial	OK/ T/C	Initial	OK/ T/C	Initial	OK/ T/C
Checked = OK Topped off/up = T Changed = C														
Bottle 1														
Bottle 2														
Bottle 3														
Bottle 4														
Bottle 5														
Bottle 6														
Bottle 7														
Bottle 8														
Bottle 9														
Bottle 10														
Bottle 11														
Bottle 12														
Bottle 13														
Bottle 14														
Bottle 15														
Bottle 16														
Wax 1														
Wax 2														
Wax 3														
Wax 4														
Clean top surface														
Clean touch-screen														
Weekly Tasks														
Empty condensate bottle														
Check reagent bottles														
Clean wax bath														
Check bottle connectors														
Clean exterior surfaces														
Every 60–90 Days														
Change carbon filter														
Check lid seals														

7.3.6 Daily Tasks

7.3.6.1 Clean Lids and Seals

Use the plastic scraper provided to scrape wax off the inside surfaces of the retort and wax bath lids. Carefully remove wax from around the lid seals using the two-pronged end of the scraper, which is specifically designed for cleaning the lid seals. Replace any seals that are damaged (see [7.3.8.2 - Check Lid Seals](#)).

Remove the retort lids to clean them thoroughly. The retort lids are specific to each retort. If you completely remove lids, ensure the correct lid is placed back on its retort. The lids are labeled: **Retort A** and **Retort B** (see [Figure 7-6](#)). To remove a lid, open it fully and slide it to the left.

Figure 7-6: Removing a retort lid

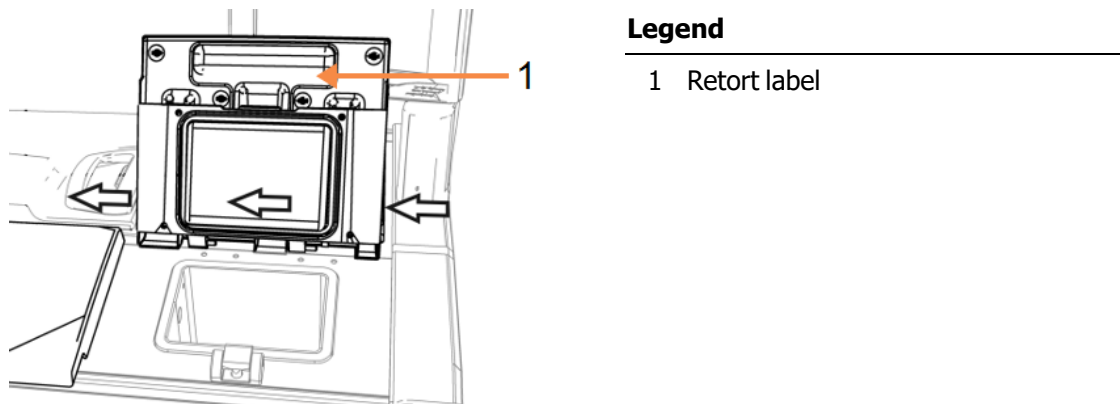

Scrape around the rims of the retorts, and around the wax bath on the top of the instrument where the lids sit. Ensure that the lids seal fully when closed.

In the wax bath, make sure that the air vent on the back rim under the left lid is clear of wax. Use the pin end of the LLS cleaning tool to block the wax vent while cleaning. This will prevent wax from falling into the wax vent.

Figure 7-7: Wax bath air vent

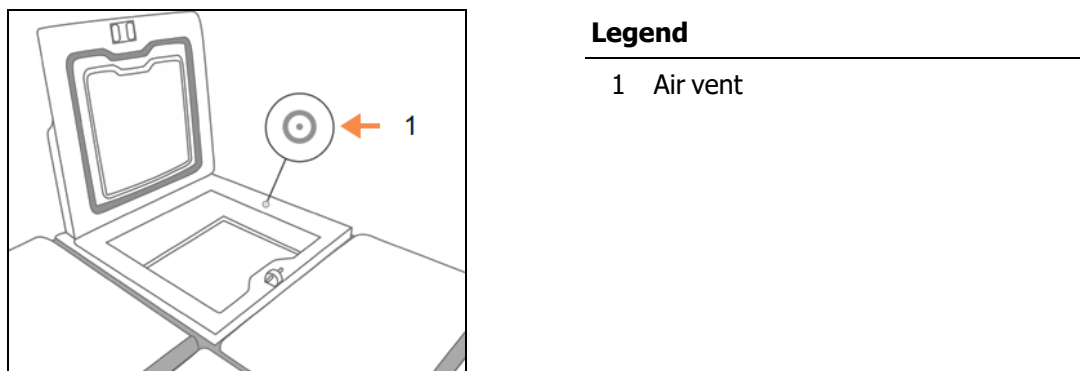

CAUTION:

To avoid damaging the retort lid seals, only use the plastic scraper provided. The scraper can also be used to clean any polished surface.

When complete, record this maintenance on the **Maintenance** screen by tapping the appropriate panel:

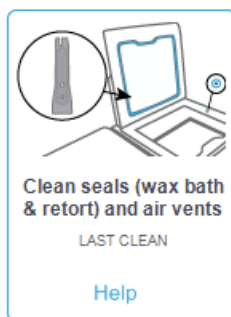

A pop-up screen with instructions is available by tapping **Help**.

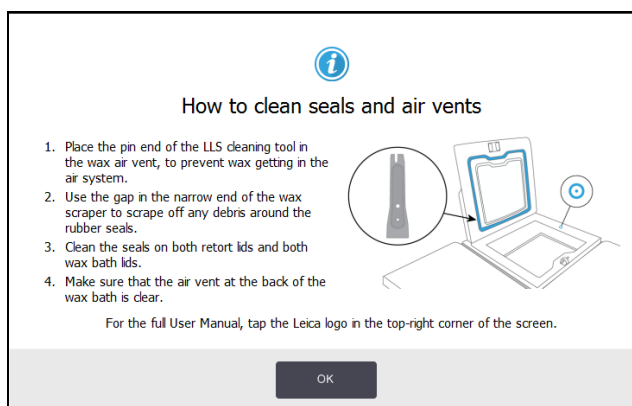

7.3.6.2 Clean Retorts and Liquid Level Sensors

Clean the retort walls and liquid level sensors daily. Use a lint-free cloth moistened with 70% alcohol.

The LLS cleaning tool (located on the back of the touch-screen; see [7.1.2 - LLS cleaning tool and wax vent plug](#)) will help ensure that the cloth reaches the entire surface of a sensor. Place the cloth over the sensor, hold it in place with the cupped end of the cleaning tool and then gently rotate the tool.

Figure 7-8: Retort interior

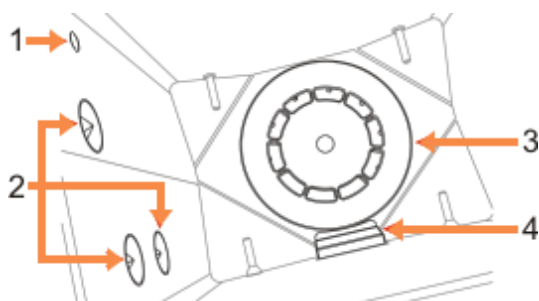

Legend

- | | |
|---|---------------|
| 1 | Air hole |
| 2 | Level sensors |
| 3 | Stirrer |
| 4 | Retort filter |

- Ensure that the air hole remains unobstructed.
- If you cannot remove stains with alcohol solution, use a lint-free cloth moistened with 6% acetic acid or CLR[®]. Wipe the surfaces again with ethanol. If still not clean, do a retort acid clean (see [7.3.9 - Retort Acid Clean](#)).
- Inspect the filter. If soiled, lift it out and clean with 70% alcohol.



CAUTION: Take care not to drop anything into the retort when the filter is removed. Foreign material in the lines could stop valves operating properly.

- Inspect the stirrer. If it is dirty, lift it out and clean with 70% alcohol. If it is damaged or showing signs of rust, contact your service representative for a new stirrer.

To replace the stirrer, hold it as indicated in [Figure 7-9](#) and carefully allow it to slide onto the spindle in the bottom of the retort.

Figure 7-9: Stirrer handling—correct (left) and incorrect (right)

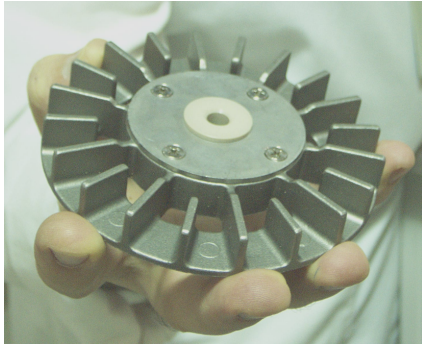

WARNING: The magnetic coupling will pull the stirrer towards the bottom of the retort. To avoid pinching your fingers, do not allow them to be trapped between the stirrer and the bottom of the retort.

- Clean the retort filter:
 - Remove the basket support and stirrer.
 - Release the retort filter by sliding it upwards.
 - Wash it thoroughly in a solution of 70% alcohol.
 - Slide it back into place. It fits snugly over two lugs in the front wall of the retort.
 - Replace the stirrer and basket support.

If the retort has a build up of salt precipitate from formalin or other fixatives that you cannot remove by wiping, run a retort acid clean ([7.3.9 - Retort Acid Clean](#)).

When complete, record this maintenance on the **Maintenance** screen by tapping the appropriate panel:

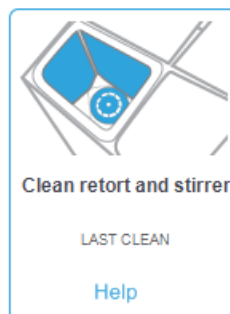

A pop-up screen with instructions is available by tapping **Help**:

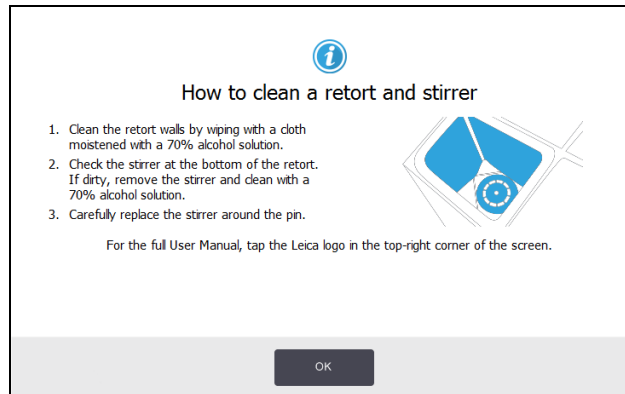

7.3.6.3 Check Bottle Fill Levels (including Condensate Bottle)

Ensure that all reagent bottles are filled to the two- or three-basket level (depending on the reagent fill level setting for your instrument: see **Settings > Instrument**). Add more reagent if required (see [5.4 - Replacing Reagents](#)). Do not fill above the MAX level.

Empty the condensate bottle if it is more than half full.

When complete, record this maintenance on the **Maintenance** screen by tapping the appropriate panel:

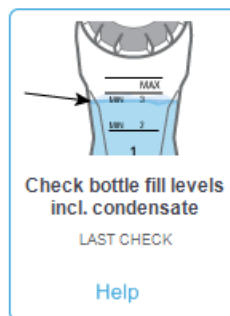

A pop-up screen with instructions is available by tapping **Help**:

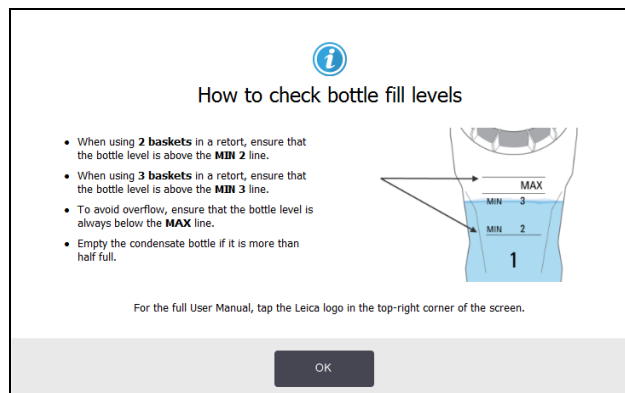

7.3.6.4 Check Wax Fill Levels

Ensure that the wax chambers are filled to the two- or three-basket level (depending on the reagent fill level setting for your instrument: see **Settings > Instrument**). Add more wax if required (see [5.4 - Replacing Reagents](#)). Do not fill above the MAX level.

When complete, record this maintenance on the Maintenance screen by tapping the appropriate panel:



A pop-up screen with instructions is available by tapping **Help**:

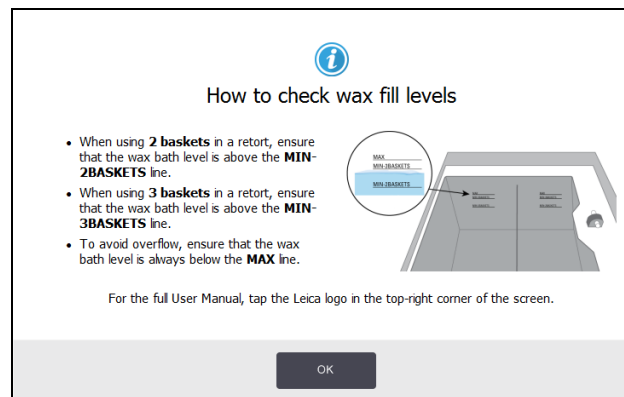

7.3.6.5 Clean Touch-Screen and Top Surface

Wipe the touch-screen (or touch-screen protector) with a lint-free cloth moistened with 70% alcohol. Check the touch-screen protector if present and replace it if necessary.



Note: Lock the touch-screen before cleaning: go to **Settings > Device**.

Never use abrasive cleaners or strong solvents on the touch-screen.

Use a lint-free cloth with 70% alcohol and, if necessary, the plastic scraper to clean the lids and other surfaces on the top of the instrument. Use the wax scraper to ensure all wax is removed. Use the wax vent plug end of the LLS cleaning tool to ensure that wax does not go down the wax bath vent (see [Figure 7-7](#)).

When complete, record this maintenance on the **Maintenance** screen by tapping the appropriate panel:

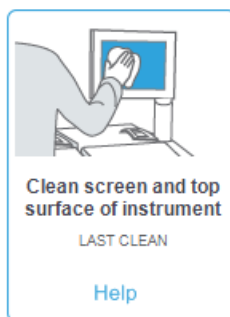

A pop-up screen with instructions is available by tapping **Help**:

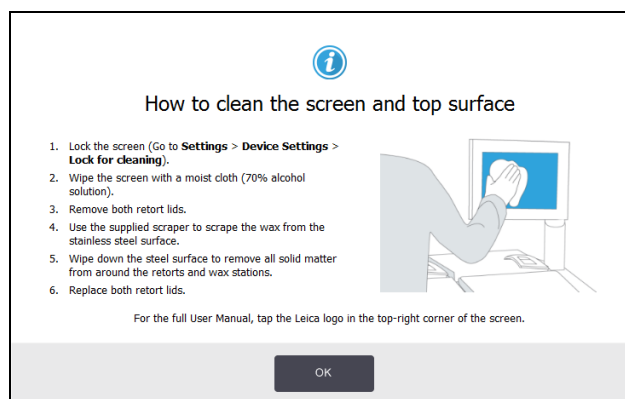

7.3.7 Weekly Tasks

7.3.7.1 Empty Condensate Bottle

Empty the condensate bottle weekly. This is especially important if running xylene-free protocols, as these produce more condensate.

7.3.7.2 Clean Reagent Bottles and Check Bottle Connectors

Check all bottles weekly. Note those bottles that are becoming dirty. Clean the bottles when next replacing reagent.

While bottles are removed, wipe the interior of the reagent cabinet with 70% alcohol.

To clean the bottles, pour in a small amount of fresh reagent (i.e. the reagent the bottle is used for), cap the openings, and shake. Use sealing caps from Leica Biosystems to seal the bottle. Empty the bottle and check that it is clean. If so, refill it and replace it in the instrument (see [5.4 - Replacing Reagents](#) for instructions to reset the station properties).

If the bottle is still stained, use a bottle brush and laboratory detergent to clean it. Rinse thoroughly with water. Then prepare the bottle to refill it with reagent:

- For formalin and alcohol bottles (where the reagent is miscible with water), rinse with a small amount of the bottle's reagent to clear the water and then refill.
- For clearer and cleaning solvent bottles (e.g. xylene, where the reagent is not miscible with water), dry thoroughly before adding fresh reagent, or rinse with a small amount of alcohol and then a small amount of the bottle's reagent before refilling.

The bottle connectors that plug into the instrument can become loose. Check the connector whenever you pull out a bottle. Tighten firmly if necessary.

Check that the O-ring on the back of the bottle is smooth and undamaged.

When complete, record this maintenance on the **Maintenance** screen by tapping the appropriate panel:



A pop-up screen with instructions is available by tapping **Help**:

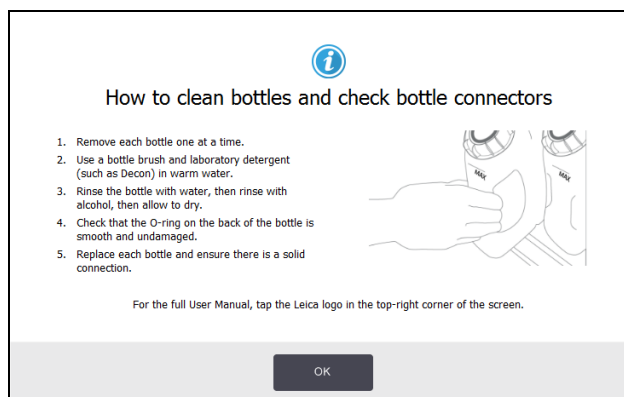

WARNING: To avoid splashes when cleaning bottles, wear suitable protective clothing and eye-wear.



WARNING: To avoid reagent spills, ensure that lids are tight and the bottles are firmly plugged into their connectors at the back of the reagent cabinet.



CAUTION: Do not clean reagent bottles in an automatic dishwasher, as they may be damaged.

7.3.7.3 Check Wax Baths

Check the wax baths weekly to see if they are becoming dirty. Clean the baths when you are next replacing the wax.

Clean the wax baths while they are warm (as they will be immediately after spent out has been drained from the instrument). Never attempt to clean a bath while the wax from the bath is in a retort.

Remove any debris or sludge from the bottom and sides of the bath by wiping them with a lint-free cloth. Be careful not to dislodge or remove the chimney filters. Use the wax vent lug on the LLS cleaning tool to ensure that wax does not go down the wax bath vent (see [Figure 7-7](#)).



WARNING: Never open a wax bath lid when there is wax in a retort or wax is being transferred. Hot wax may splash out of the bath and cause burns.



WARNING: Take care when cleaning the wax bath walls. The walls could be hot and may cause burns.

7.3.7.4 Clean Exterior Surfaces

Wipe down the exterior surfaces of the PELORIS 3 weekly with a cloth dampened with water or 70% alcohol. Do not use strong solvents.

Dry with a lint-free cloth.

7.3.8 60–90 Days

7.3.8.1 Change Carbon Filter

Change the carbon filter every 60 to 90 days.



WARNING: Always replace the carbon filter when the software indicates that it has expired. Running the instrument with an out-of-date carbon filter may release potentially dangerous fumes into the laboratory.

Supervisors should ensure that the carbon filter threshold is set to a suitable value so that operators will be alerted when the filter needs to be changed. The carbon filter threshold setting can be found in **Settings > Instrument > Device thresholds**.

To replace a filter:

1. Unlock the filter by turning the latch 90° clockwise ([Figure 7-10](#)) and pull on the tag to slide the old filter out ([Figure 7-11](#)).

Figure 7-10: Unlocking the filter

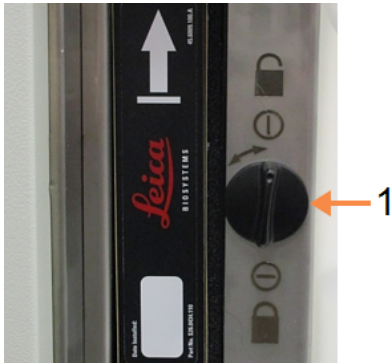

Legend

- 1 Latch turned to open position

Figure 7-11: Removing the filter



Legend

- 1 Slide filter out by pulling on the tag

2. Remove a new filter from its plastic wrap.
3. Slide the new filter into the housing with the direction arrow pointing up ([Figure 7-12](#)).

4. Turn the latch 90° counterclockwise to lock the filter in place (see [Figure 7-13](#)).

Figure 7-12: Replacing the carbon filter with direction arrow (1) pointing up



Legend

- 1 Slide filter in with the arrow pointing upward

Figure 7-13: Locking the filter

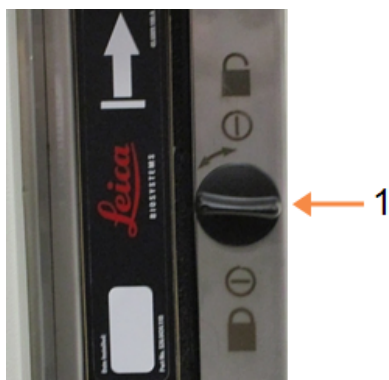

Legend

- 1 Latch turned to closed position

5. Supervisors should reset the carbon filter age in **Settings > Instrument > Carbon filter age**.

When complete, record this maintenance on the **Maintenance** screen by tapping the appropriate panel:

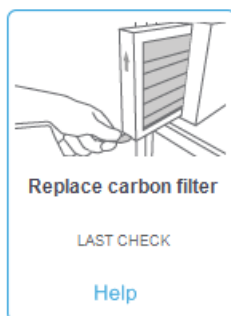

A pop-up screen with instructions is available by tapping **Help**:

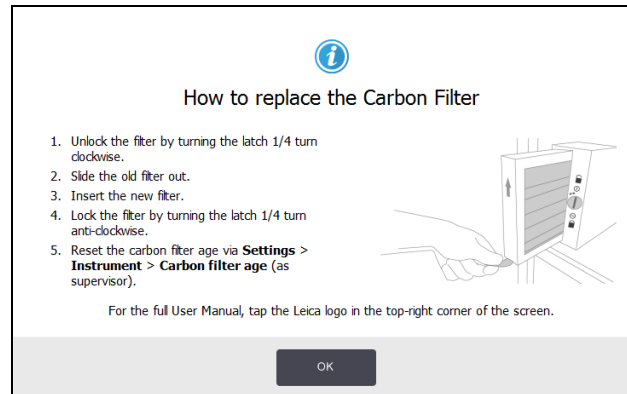

7.3.8.2 Check Lid Seals

Every 60–90 days, inspect the seals around the retort lids and wax bath lids. Replace a seal if it is worn or damaged.

To replace a seal:

1. Pull the old seals out of their retaining grooves.
2. Clean the grooves if necessary with the thin end of the wax scraper and 70% alcohol.
3. Push the new seals into the grooves. Ensure they are fully seated.

[Figure 7-14](#) and [Figure 7-15](#) show how the seals fit into the grooves.

Figure 7-14: Cross section of retort seal in lid Figure 7-15: Cross section of wax bath seal in

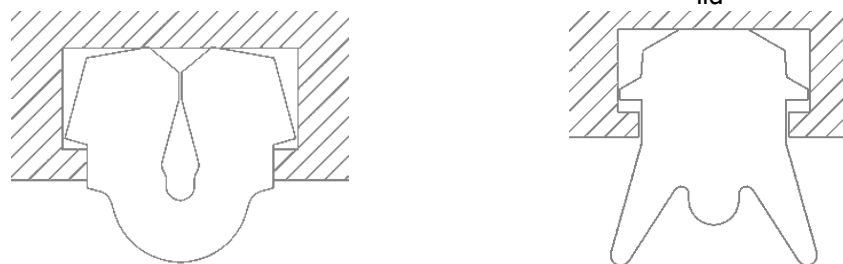

4. Equalize the tension in each seal by running your finger around the seal. This should remove any tight or loose sections.

7.3.9 Retort Acid Clean

Common fixative reagents (such as formalin) may cause a build up of precipitate (salt crystals) on the retort walls. If this cannot be removed by wiping the walls with 70% alcohol, follow the procedure below.

1. If the salt build-up is light, wipe the retort walls with a lint-free cloth dampened with 6% acetic acid. If this is successful, continue from [step 3](#) below.
2. If the build-up is heavy or not easily removed:
 - i. Fill a reagent bottle with 6% acetic acid solution.
 - ii. Fill the retort with the solution using the instrument's remote fill function (see [5.4.6 - Filling and Draining Retorts](#)).
 - iii. Leave the acetic acid solution in the retort for one hour at ambient temperature and then drain the acid back into the bottle. Use the remote drain function (see [5.4.6 - Filling and Draining Retorts](#)).
 - iv. Remove the acetic acid solution from the bottle and clean it thoroughly before reusing.
 - v. Use a clean wax scraper or a lint-free cloth dampened with the acetic acid solution to remove any remaining salt build-up.
3. Run a cleaning protocol in the retort with a cleaning alcohol as the initial step.



WARNING: Wear suitable protective clothing when handling the acetic acid solution.

8. Reference

This chapter has useful reference information to help you set up and operate the PELORIS 3. It has the following sections:

- [8.1 - Reagent Threshold Guidelines](#)
- [8.2 - Protocols](#)
- [8.3 - Station Configurations](#)
- [8.4 - Protocol Step Temperatures](#)
- [8.5 - Reagent Compatibility Tables](#)

8.1 Reagent Threshold Guidelines

The tables in this section list the recommended thresholds for commonly used reagents. There are separate tables for xylene and xylene-free processing:

8.1.1 Xylene Processing

For the best results, xylene-processing reagent changes should be based on concentration thresholds, while cleaning reagent thresholds should be based on cycles.

Thresholds for xylene-processing reagents, including cleaning reagents, using non-graded alcohol are:

Type	Reagent change thresholds		Final reagent thresholds		Max. temperatures °C		
	Conc. (%)	Cassettes or cycles	Conc. (%)	Cassettes or cycles	Ambient	Vacuum	Safe
Formalin	98.0	1500 cass.	N/A	N/A	60	60	45
Ethanol	51.0	N/A	98.0	1500 cass.	78	51	45
Xylene	68.0	N/A	95.0	1500 cass.	138	99	45
Wax	80.0	4500 cass.	95.0	1500 cass.	100	100	77
Cleaning xylene	88.0	10 cycles	N/A	N/A	138	99	45
Cleaning ethanol	88.0	10 cycles	N/A	N/A	78	51	45

8.1.2 Xylene-free Processing

In general, xylene-free processing reagent changes should be based on concentration thresholds, and cleaning reagent changes based on cycles.

Type	Reagent change thresholds		Final reagent thresholds		Max. temperatures °C		
	Conc. (%)	Cassettes or cycles	Conc. (%)	Cassettes or cycles	Ambient	Vacuum	Safe
Formalin	98.0	1500 cass.	N/A	N/A	60	60	45
85% ethanol	50.0	N/A	N/A	N/A	87	55	45
80/20 ethanol/IPA	81.0	N/A	N/A	N/A	78	51	45
IPA	90.0	4500 cass.	95.0	1500 cass.	82	55	45
Wax	85.0	4500 cass.	95.0	1500 cass.	100	100	77
Cleaning Waxesol	88.0	6 cycles*	N/A	N/A	100	100	45
Cleaning ethanol	88.0	6 cycles*	N/A	N/A	78	51	45

* This differs from the recommendation for cleaning ethanol in xylene processing because the cleaning solvent in xylene-free protocols is less efficient than the cleaning solvent in xylene protocols.

8.2 Protocols

The protocols in this section have been developed, and extensively tested, by Leica Biosystems for use on the PELORIS 3 tissue processor. Some are included as pre-defined protocols with all PELORIS 3 systems.



When used for the recommended tissue types, the protocols all produce optimum processing quality with consistent, high-quality results. Use these protocols and the suggested station configurations (see [8.3 - Station Configurations](#)) as a reference point when developing protocols that suit your specific requirements and practices.

This section has the following subsections:

- [8.2.1 - Specimen Type and Protocol Duration](#)
- [8.2.2 - List of Pre-defined Protocols](#)
- [8.2.3 - Xylene Protocols](#)
- [8.2.4 - Xylene-free Protocols](#)
- [8.2.5 - Cleaning Protocol](#)

8.2.1 Specimen Type and Protocol Duration

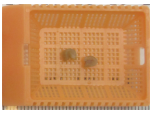
The following table lists recommended protocol durations for different specimen types.

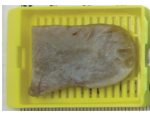
Protocol (hours)	Maximum tissue thickness (mm)	Example	Specimen type: Examples
1	1.5		Endoscopies and needle biopsies
2	< 3		All biopsies up to 3 mm diameter: gastrointestinal biopsies, renal, prostatic, hepatic and breast cores; punch biopsies of skin, small colonic polyps
4	3		Small specimens of non-dense tissues (e.g. kidney, liver, bowel), excisional and incisional skin biopsies; skin ellipses
6–8	15 × 10 × 4		All routine tissues up to maximum dimensions (excluding brain specimens)
12	20 × 10 × 5		All routine tissues up to maximum dimensions. Very thick fatty specimens may require a longer protocol.

8.2.2 List of Pre-defined Protocols

Leica Biosystems provides 11 pre-defined protocols with each PELORIS 3 system. You can use these as they are, or base new protocols on them (see [4.2.3.2 - Copying Protocols](#) for instructions on how to copy pre-defined protocols).

A description of each pre-defined protocol is given in the following sections.

The pre-defined protocols are:

- Factory 1hr Xylene Standard (see [8.2.3.1 - Xylene 1 Hour](#))
- Factory 2hr Xylene Standard (see [8.2.3.2 - Xylene 2 Hour](#))
- Factory 4hr Xylene Standard (see [8.2.3.3 - Xylene 4 Hour](#))
- Factory 8hr Xylene Standard (see [8.2.3.5 - Xylene 8 Hour](#))
- Factory 12hr Xylene Standard (see [8.2.3.6 - Xylene 12 Hour](#))
- Factory 1 hr Xylene Free (see [8.2.4.1 - Xylene-free 1 Hour](#))
- Factory 2 hr Xylene Free (see [8.2.4.2 - Xylene-free 2 Hour](#))
- Factory 4 hr Xylene Free (see [8.2.4.3 - Xylene-free 4 Hour](#))
- Factory 8 hr Xylene Free (see [8.2.4.5 - Xylene-free 8 Hour](#))
- Factory 12 hr Xylene Free (see [8.2.4.6 - Xylene-free 12 Hour](#))
- Quick Clean (see [8.2.5.1 - Quick Clean](#))

8.2.3 Xylene Protocols

All the xylene protocols below are designed for use with the xylene bottle configuration shown in [8.3 - Station Configurations](#).

Note that the processing time shown for each protocol is the sum of the step time and drip time for each step plus the total fill and drain time. The step time and drip time is shown for each step in a protocol; the fill and drain time is not.

8.2.3.1 Xylene 1 Hour

- Pre-defined protocol "Factory 1hr Xylene Standard"
- Carryover setting: 100

Step	Reagent type	Reagent group	Time (min)	Temp (°C)	P/V	Stirrer	Drip time (s)
1	Formalin	Fixatives	1	Ambient	Ambient	Medium	10
2	Ethanol	Dehydrants	1	Ambient	Ambient	Medium	10
3	Ethanol	Dehydrants	1	Ambient	Ambient	Medium	10
4	Ethanol	Dehydrants	1	Ambient	Ambient	Medium	10
5	Ethanol	Dehydrants	1	Ambient	Ambient	Medium	10
6	Ethanol	Dehydrants	1	Ambient	Ambient.	Medium	10
7	Ethanol	Dehydrants	18	45	Ambient	Medium	10
8	Xylene	Clearers	1	Ambient	Ambient	Medium	10
9	Xylene	Clearers	1	Ambient	Ambient	Medium	10
10	Xylene	Clearers	14	45	Ambient	Medium	10
11	Paraffin wax	Wax	2	65	Vacuum	Medium	10
12	Paraffin wax	Wax	1	65	Vacuum	Medium	10
13	Paraffin wax	Wax	14	65	Vacuum	Medium	10
Processing time:			1:25:00				

8.2.3.2 Xylene 2 Hour

- Pre-defined protocol "Factory 2hr Xylene Standard"
- Carryover setting: 75

Step	Reagent type	Reagent group	Time (min)	Temp (°C)	P/V	Stirrer	Drip time (s)
1	Formalin	Fixatives	1	Ambient	Ambient	Medium	10
2	Ethanol	Dehydrants	1	Ambient	Ambient	Medium	10
3	Ethanol	Dehydrants	1	Ambient	Ambient	Medium	10
4	Ethanol	Dehydrants	1	Ambient	Ambient	Medium	10
5	Ethanol	Dehydrants	1	Ambient	Ambient	Medium	10
6	Ethanol	Dehydrants	11	45	Ambient	Medium	10
7	Ethanol	Dehydrants	30	45	Ambient	Medium	10
8	Xylene	Clearers	1	Ambient	Ambient	Medium	10
9	Xylene	Clearers	1	Ambient	Ambient	Medium	10
10	Xylene	Clearers	28	45	Ambient	Medium	10
11	Paraffin wax	Wax	5	65	Vacuum	Medium	10
12	Paraffin wax	Wax	5	65	Vacuum	Medium	10
13	Paraffin wax	Wax	20	65	Vacuum	Medium	10
Processing time:			2:14:00				

8.2.3.3 Xylene 4 Hour

- Pre-defined protocol "Factory 4hr Xylene Standard"
- Carryover setting: 50

Step	Reagent type	Reagent group	Time (min)	Temp (°C)	P/V	Stirrer	Drip time (s)
1	Formalin	Fixatives	10	45	Ambient	Medium	10
2	Ethanol	Dehydrants	1	Ambient	Ambient	Medium	10
3	Ethanol	Dehydrants	1	Ambient	Ambient	Medium	10
4	Ethanol	Dehydrants	1	Ambient	Ambient	Medium	10
5	Ethanol	Dehydrants	20	45	Ambient	Medium	10
6	Ethanol	Dehydrants	20	45	Ambient	Medium	10
7	Ethanol	Dehydrants	45	45	Ambient	Medium	10
8	Xylene	Clearers	1	Ambient	Ambient	Medium	10
9	Xylene	Clearers	10	45	Ambient	Medium	10
10	Xylene	Clearers	45	45	Ambient	Medium	10
11	Paraffin wax	Wax	10	65	Vacuum	Medium	10
12	Paraffin wax	Wax	10	65	Vacuum	Medium	10
13	Paraffin wax	Wax	40	65	Vacuum	Medium	10
Processing time:			4:02:00				

8.2.3.4 Xylene 6 Hour

- Not a pre-defined protocol

Step	Reagent type	Reagent group	Time (min)	Temp (°C)	P/V	Stirrer	Drip time (s)
1	Formalin	Fixatives	15	45	Ambient	Medium	10
2	Ethanol	Dehydrants	15	45	Ambient	Medium	10
3	Ethanol	Dehydrants	15	45	Ambient	Medium	10
4	Ethanol	Dehydrants	15	45	Ambient	Medium	10
5	Ethanol	Dehydrants	15	45	Ambient	Medium	10
6	Ethanol	Dehydrants	30	45	Ambient	Medium	10
7	Ethanol	Dehydrants	45	45	Ambient	Medium	10
8	Xylene	Clearers	20	45	Ambient	Medium	10
9	Xylene	Clearers	20	45	Ambient	Medium	10
10	Xylene	Clearers	45	45	Ambient	Medium	10
11	Paraffin wax	Wax	30	65	Vacuum	Medium	10
12	Paraffin wax	Wax	30	65	Vacuum	Medium	10
13	Paraffin wax	Wax	45	65	Vacuum	Medium	10
Processing time:			6:08:00				

8.2.3.5 Xylene 8 Hour

- Pre-defined protocol "Factory 8hr Xylene Standard"
- Carryover setting: 25

Step	Reagent type	Reagent group	Time (min)	Temp (°C)	P/V	Stirrer	Drip time (s)
1	Formalin	Fixatives	20	45	Ambient	Medium	10
2	Ethanol	Dehydrants	20	45	Ambient	Medium	10
3	Ethanol	Dehydrants	20	45	Ambient	Medium	10
4	Ethanol	Dehydrants	20	45	Ambient	Medium	10
5	Ethanol	Dehydrants	20	45	Ambient	Medium	10
6	Ethanol	Dehydrants	40	45	Ambient	Medium	10
7	Ethanol	Dehydrants	60	45	Ambient	Medium	10
8	Xylene	Clearers	30	45	Ambient	Medium	10
9	Xylene	Clearers	30	45	Ambient	Medium	10
10	Xylene	Clearers	60	45	Ambient	Medium	10
11	Paraffin wax	Wax	40	65	Vacuum	Medium	10
12	Paraffin wax	Wax	40	65	Vacuum	Medium	10
13	Paraffin wax	Wax	60	65	Vacuum	Medium	10
Processing time:			8:08:00				

8.2.3.6 Xylene 12 Hour

- Pre-defined protocol "Factory 12hr Xylene Standard"
- Carryover setting: 25

Step	Reagent type	Reagent group	Time (min)	Temp (°C)	P/V	Stirrer	Drip time (s)
1	Formalin	Fixatives	44	45	Ambient	Medium	10
2	Ethanol	Dehydrants	30	45	Ambient	Medium	10
3	Ethanol	Dehydrants	30	45	Ambient	Medium	10
4	Ethanol	Dehydrants	30	45	Ambient	Medium	10
5	Ethanol	Dehydrants	30	45	Ambient	Medium	10
6	Ethanol	Dehydrants	60	45	Ambient	Medium	10
7	Ethanol	Dehydrants	90	45	Ambient	Medium	10
8	Xylene	Clearers	45	45	Ambient	Medium	10
9	Xylene	Clearers	45	45	Ambient	Medium	10
10	Xylene	Clearers	90	45	Ambient	Medium	10
11	Paraffin wax	Wax	60	65	Vacuum	Medium	10
12	Paraffin wax	Wax	60	65	Vacuum	Medium	10
13	Paraffin wax	Wax	80	65	Vacuum	Medium	10
Processing time:			12:02:00				

8.2.4 Xylene-free Protocols

All the xylene-free protocols below are designed for use with the xylene-free bottle configuration in [8.3 - Station Configurations](#).

Note that the processing time shown for each protocol is the sum of the step time and drip time for each step plus the total fill and drain time. The step time and drip time is shown for each step in a protocol; the fill and drain time is not.

8.2.4.1 Xylene-free 1 Hour

- Pre-defined protocol "Factory 1 hr Xylene Free"
- Carryover setting: 100

Step	Reagent type	Time (min)	Temp (°C)	P/V	Stirrer	Drip time (s)
1	Formalin	1	Ambient	Ambient	Medium	10
2	85% Ethanol	1	Ambient	Ambient	Medium	10
3	85% Ethanol	6	55	Ambient	Medium	10
4	80/20 Ethanol/IPA	1	Ambient	Ambient	Medium	10
5	80/20 Ethanol/IPA	6	55	Ambient	Medium	10
6	IPA	1	Ambient	Ambient	Medium	10
7	IPA	1	Ambient	Ambient	Medium	10
8	IPA	12	55	Ambient	Medium	10
9	Wax	20	85	Vacuum	Medium	10
10	Wax	5	85	Vacuum	Medium	10
11	Wax	1	65	Vacuum	Medium	10
Processing time:		1:19:00				

8.2.4.2 Xylene-free 2 Hour

- Pre-defined protocol "Factory 2 hr Xylene Free"
- Carryover setting: 75

Step	Reagent type	Time (min)	Temp (°C)	P/V	Stirrer	Drip time (s)
1	Formalin	1	Ambient	Ambient	Medium	10
2	85% Ethanol	1	Ambient	Ambient	Medium	10
3	85% Ethanol	12	55	Ambient	Medium	10
4	80/20 Ethanol/IPA	1	Ambient	Ambient	Medium	10
5	80/20 Ethanol/IPA	25	55	Ambient	Medium	10
6	IPA	1	Ambient	Ambient	Medium	10
7	IPA	1	Ambient	Ambient	Medium	10
8	IPA	25	55	Ambient	Medium	10
9	Wax	25	85	Vacuum	Medium	10
10	Wax	10	85	Vacuum	Medium	10
11	Wax	5	65	Vacuum	Medium	10
Processing time:		2:11:00				

8.2.4.3 Xylene-free 4 Hour

- Pre-defined protocol "Factory 4 hr Xylene Free"
- Carryover setting: 50

Step	Reagent type	Time (min)	Temp (°C)	P/V	Stirrer	Drip time (s)
1	Formalin	10	55	Ambient	Medium	10
2	85% Ethanol	3	Ambient	Ambient	Medium	10
3	85% Ethanol	22	55	Ambient	Medium	10
4	80/20 Ethanol/IPA	10	Ambient	Ambient	Medium	10
5	80/20 Ethanol/IPA	40	55	Ambient	Medium	10
6	IPA	3	Ambient	Ambient	Medium	10
7	IPA	10	55	Ambient	Medium	10
8	IPA	45	55	Ambient	Medium	10
9	Wax	45	85	Vacuum	Medium	10
10	Wax	20	85	Vacuum	Medium	10
11	Wax	10	65	Vacuum	Medium	10
Processing time:		4:02:00				

8.2.4.4 Xylene-free 6 Hour

- Not a pre-defined protocol

Step	Reagent type	Time (min)	Temp (°C)	P/V	Stirrer	Drip time (s)
1	Formalin	20	55	Ambient	Medium	10
2	85% Ethanol	15	55	Ambient	Medium	10
3	85% Ethanol	20	55	Ambient	Medium	10
4	80/20 Ethanol/IPA	20	55	Ambient	Medium	10
5	80/20 Ethanol/IPA	45	55	Ambient	Medium	10
6	IPA	15	55	Ambient	Medium	10
7	IPA	30	55	Ambient	Medium	10
8	IPA	60	55	Ambient	Medium	10
9	Wax	45	85	Vacuum	Medium	10
10	Wax	40	85	Vacuum	Medium	10
11	Wax	30	65	Vacuum	Medium	10
Processing time:		6:04:00				

8.2.4.5 Xylene-free 8 Hour

- Pre-defined protocol "Factory 8 hr Xylene Free"
- Carryover setting: 26

Step	Reagent type	Time (min)	Temp (°C)	P/V	Stirrer	Drip time (s)
1	Formalin	30	55	Ambient	Medium	10
2	85% Ethanol	20	55	Ambient	Medium	10
3	85% Ethanol	30	55	Ambient	Medium	10
4	80/20 Ethanol/IPA	30	55	Ambient	Medium	10
5	80/20 Ethanol/IPA	60	55	Ambient	Medium	10
6	IPA	20	55	Ambient	Medium	10
7	IPA	40	55	Ambient	Medium	10
8	IPA	80	55	Ambient	Medium	10
9	Wax	60	85	Vacuum	Medium	10
10	Wax	50	85	Vacuum	Medium	10
11	Wax	40	65	Vacuum	Medium	10
Processing time:		8:04:00				

8.2.4.6 Xylene-free 12 Hour

- Pre-defined protocol "Factory 12 hr Xylene Free"
- Carryover setting: 26

Step	Reagent type	Time (min)	Temp (°C)	P/V	Stirrer	Drip time (s)
1	Formalin	68	55	Ambient	Medium	10
2	85% Ethanol	30	55	Ambient	Medium	10
3	85% Ethanol	40	55	Ambient	Medium	10
4	80/20 Ethanol/IPA	50	55	Ambient	Medium	10
5	80/20 Ethanol/IPA	90	55	Ambient	Medium	10
6	IPA	30	55	Ambient	Medium	10
7	IPA	60	55	Ambient	Medium	10
8	IPA	120	55	Ambient	Medium	10
9	Wax	80	85	Vacuum	Medium	10
10	Wax	70	85	Vacuum	Medium	10
11	Wax	60	65	Vacuum	Medium	10
Processing time:		12:02:00				

8.2.5 Cleaning Protocol

8.2.5.1 Quick Clean

- Pre-defined protocol "Quick Clean".
- Bottle configuration: one bottle each of cleaning solvent and cleaning alcohol.
- Never run a cleaning protocol while tissue is in the retort, as the dry step will damage the tissue.

Step	Reagent group	Time (min)	Temp (°C)	P/V	Stirrer	Drip time (s)
1	Cleaning solvents	12	75	Ambient	High	10
2	Cleaning alcohols	6	55	Ambient	High	10
3	Dry step	12	80	N/A	Off	N/A
Processing time:		0:34:00				

8.3 Station Configurations

Use the station configurations in this section for the protocols described in [8.2 - Protocols](#).

If considering alternative station configurations, remember to take into account how you will configure your protocols, including the reagent selection method (see [4.1.2 - Reagent Selection Method](#)). For example, some laboratories use explicitly graded alcohols with reagent types identified as "Ethanol 70%", "Ethanol 90%" etc. This sort of station configuration requires that protocols use type (or station) selection, and the protocols must be configured to use the alcohol grades in the correct order.

8.3.1 Xylene Configuration

This is the suggested station configuration when running xylene protocols (see [8.2.3 - Xylene Protocols](#)). See note below for special conditions for initial bottle setup and when doing a complete change of all ethanol bottles.

Station	Reagent type	Reagent group
Bottle 1	Formalin	Fixative
Bottle 2	Formalin	Fixative
Bottle 3	Ethanol*	Dehydrant
Bottle 4	Ethanol*	Dehydrant
Bottle 5	Ethanol	Dehydrant
Bottle 6	Ethanol	Dehydrant
Bottle 7	Ethanol	Dehydrant
Bottle 8	Ethanol	Dehydrant
Bottle 9	Ethanol	Dehydrant
Bottle 10	Ethanol	Dehydrant
Bottle 11	Xylene	Clearer
Bottle 12	Xylene	Clearer
Bottle 13	Xylene	Clearer
Bottle 14	Xylene	Clearer
Bottle 15	Cleaning xylene	Cleaning solvent
Bottle 16	Cleaning ethanol	Cleaning alcohol
Wax 1	Wax	Wax
Wax 2	Wax	Wax
Wax 3	Wax	Wax
Wax 4	Wax	Wax

* All alcohol dehydrants after fixative should be labeled and named in the software "Ethanol". However, if setting up bottles on a new instrument or replacing all the ethanol bottles at once, the first and second bottles should be filled with 70% and 90% ethanol respectively. As operation continues and you are prompted to replace degraded bottles, replace with 100% ethanol. Other, initially higher-concentration bottles will have degraded, so there will always be at least one bottle at a low concentration.

8.3.2 Xylene-free Configuration

This is the suggested station configuration when running xylene-free protocols (see [8.2.4 - Xylene-free Protocols](#)). See the note below the table for special conditions that apply to the initial bottle setup and when replacing all the 85% ethanol bottles at once.

Station	Reagent type
Bottle 1	Formalin
Bottle 2	Formalin
Bottle 3	85% Ethanol*
Bottle 4	85% Ethanol*
Bottle 5	85% Ethanol
Bottle 6	80/20 Ethanol/IPA
Bottle 7	80/20 Ethanol/IPA
Bottle 8	80/20 Ethanol/IPA
Bottle 9	IPA
Bottle 10	IPA
Bottle 11	IPA
Bottle 12	IPA
Bottle 13	Waxsol™
Bottle 14	Waxsol™
Bottle 15	Cleaning ethanol
Bottle 16	Cleaning ethanol
Wax 1	Wax
Wax 2	Wax
Wax 3	Wax
Wax 4	Wax

* All alcohol dehydrants after fixative should be labeled and named in the software "85% Ethanol". However, if setting up bottles on a new instrument or replacing all the ethanol bottles at once, the first two bottles should be filled with 70% ethanol (but still be named "85% Ethanol"). As operation continues and you are prompted to replace degraded bottles, replace with 85% ethanol. Other, initially higher-concentration bottles will have degraded, so there will always be at least one bottle at a low concentration.

8.4 Protocol Step Temperatures

The PELORIS 3 tissue processor uses five protocol types to accommodate different types of processing. Each type has a set of reagent compatibility sequences that comply with the intended use (see [8.5 - Reagent Compatibility Tables](#) for more information). The allowable temperature range for each step is also dependent on the protocol type. The following sections list the protocol temperature ranges and typical protocol sequences.

Protocol type	Retort temperature range for reagent	Retort temperature range for wax	Wax bath temperature range
Standard	35 °C to 65 °C	2 °C above wax melt temp. to 77 °C	55 °C to 85 °C
Xylene-free	35 °C to 65 °C	2 °C above wax melt temp. to 85 °C	55 °C to 85 °C
Cleaning	35 °C to 85 °C	N/A	55 °C to 85 °C

To see the current wax melting temperature, go to **Reagents > Stations > Wax chambers**.

8.5 Reagent Compatibility Tables

The reagent compatibility tables determine the allowable reagent sequences. The sequences vary depending on the operation or protocol type.

8.5.1 Manual Operations

Current step	Previous step						
	None	Fixatives	Dehydrants	Clearers	Wax	Cleaning solvents	Cleaning alcohols
✓ = compatible							
Fixatives	✓	✓	✓				✓
Dehydrants	✓	✓	✓	✓		✓	✓
Clearers	✓		✓	✓		✓	✓
Wax	✓			✓	✓	✓	
Cleaning solvents	✓		✓	✓	✓	✓	✓
Cleaning alcohols	✓	✓	✓	✓		✓	✓

8.5.2 Standard Protocols

Current step	Previous step						
	None	Fixatives	Dehydrants	Clearers	Wax	Cleaning solvents	Cleaning alcohols
✓ = compatible							
Fixatives	✓	✓					✓
Dehydrants	✓	✓	✓				✓
Clearers	✓		✓	✓			
Wax	✓			✓	✓		

8.5.3 Xylene-free Protocols

Current step	Previous step						
	None	Fixatives	Dehydrants	Clearers	Wax	Cleaning solvents	Cleaning alcohols
✓ = compatible							
Fixatives	✓	✓					✓
Dehydrants	✓	✓	✓				✓
Clearers							
Wax	✓		✓		✓		

8.5.4 Cleaning Protocols

Current step	Previous step						
✓ = compatible	None	Fixatives	Dehydrants	Clearers	Wax	Cleaning solvents	Cleaning alcohols
Cleaning solvents	✓		✓	✓	✓	✓	✓
Cleaning alcohols	✓	✓	✓	✓		✓	✓

9. Troubleshooting

If you have processing problems, this chapter might help you identify the cause. It contains the following subsections:

- [9.1 - Preliminary Questions](#)
- [9.2 - Flowcharts](#)
- [9.3 - Reprocessing Recommendations](#)

9.1 Preliminary Questions

When faced with blocks that are difficult to section, first collect as much information as possible to assist in analyzing the problem. Some questions to ask are:

1. Did the instrument software indicate an error in the run? Instrument warnings and alarms will be displayed on screen and in the event log.
2. Was there anything different about the run that produced the problem specimens compared to previous successful runs, e.g. a recently changed reagent bottle?
3. Is there a possibility that an error was made when replacing reagents on the processor? Check that the correct reagent is in each bottle.
4. The **Reagent Stations** screen records reagent concentrations. It also shows how many cassettes have been put through a reagent and how many cycles have used the reagent since the reagent was last changed. Check if these are correct.
5. Are any reagents over their recommended purity thresholds?
6. Was the intended processing protocol actually used? For example, is it possible that specimens intended for a longer processing protocol were placed on a shorter processing protocol?
7. Were the specimens processed using the usual protocol for specimens of this size and type, and that generally produces good results? If so, the problem is probably not in the protocol parameters.
8. Were the specimens at the very top of the retort? Is the instrument set up for a two-basket level when three baskets were processed? Were the baskets placed in the retort correctly?
9. Were all the specimens in the batch affected, or just some of them? Were all the specimens of a similar type? Were they all from the same source? Answers to these questions may indicate a problem prior to tissue processing.
10. Was normal fixation applied to the problem specimens?

These questions should help you determine what has gone wrong. If you remain uncertain as to the cause of the problem, you should gather as much information as possible by carefully examining the specimens. Close examination of the blocks can confirm what you suspect may have happened. Microscopic examination will also provide valuable information as to what may have gone wrong.

9.2 Flowcharts

This section has eight flowcharts, on each for different processing problems.

- [9.2.1 - Under-processed Tissue – Instrument Setup](#)
- [9.2.2 - Over-processed Tissue – Instrument Setup](#)
- [9.2.3 - Under- or Over-processed Tissue – Reagents](#)
- [9.2.4 - Poor Processing – Incorrect Protocol](#)
- [9.2.5 - Poor Processing – Correct Protocol](#)
- [9.2.6 - Cutting Artifact](#)
- [9.2.7 - Staining Artifact](#)
- [9.2.8 - Block Artifact](#)

9.2.1 Under-processed Tissue – Instrument Setup

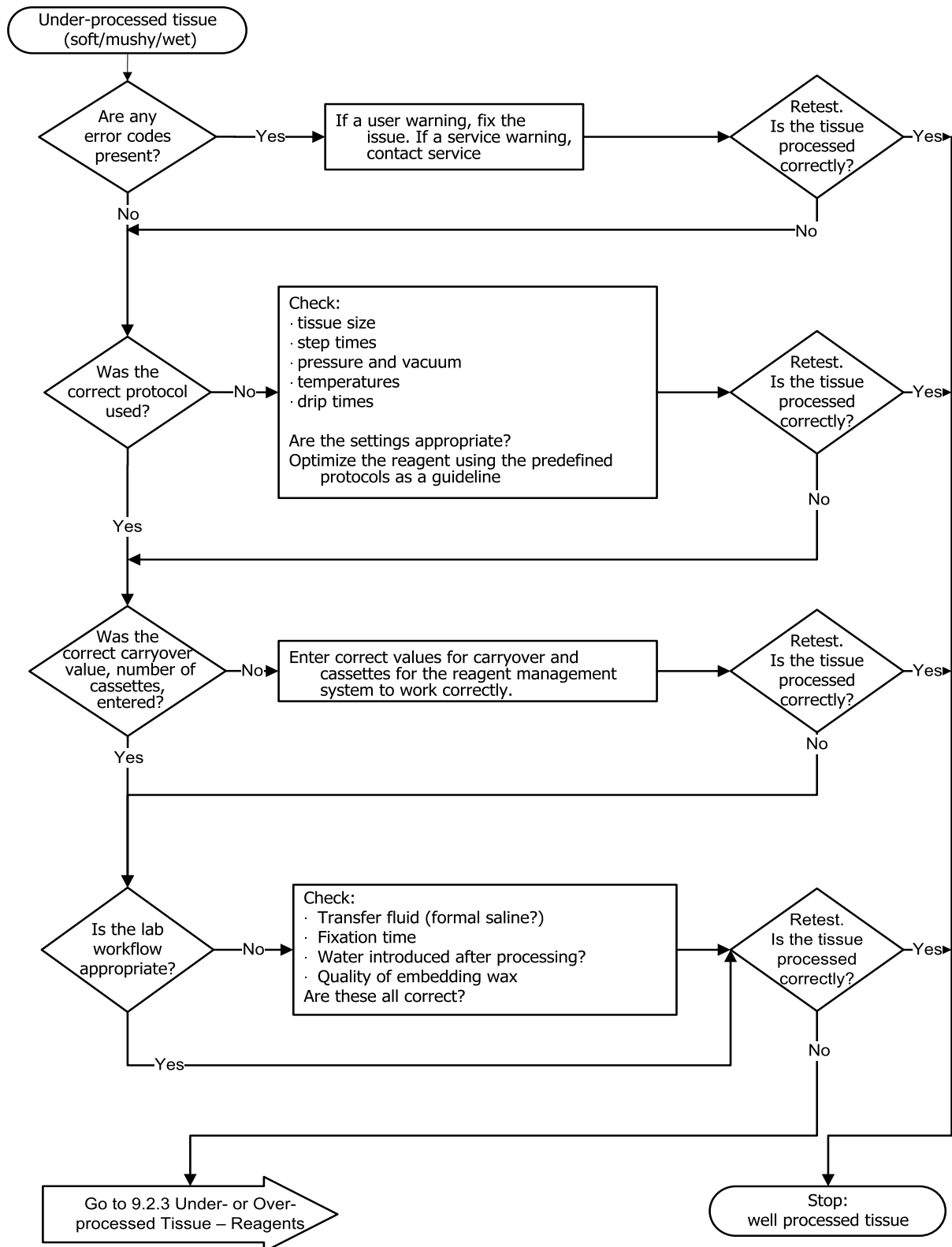

9.2.2 Over-processed Tissue – Instrument Setup

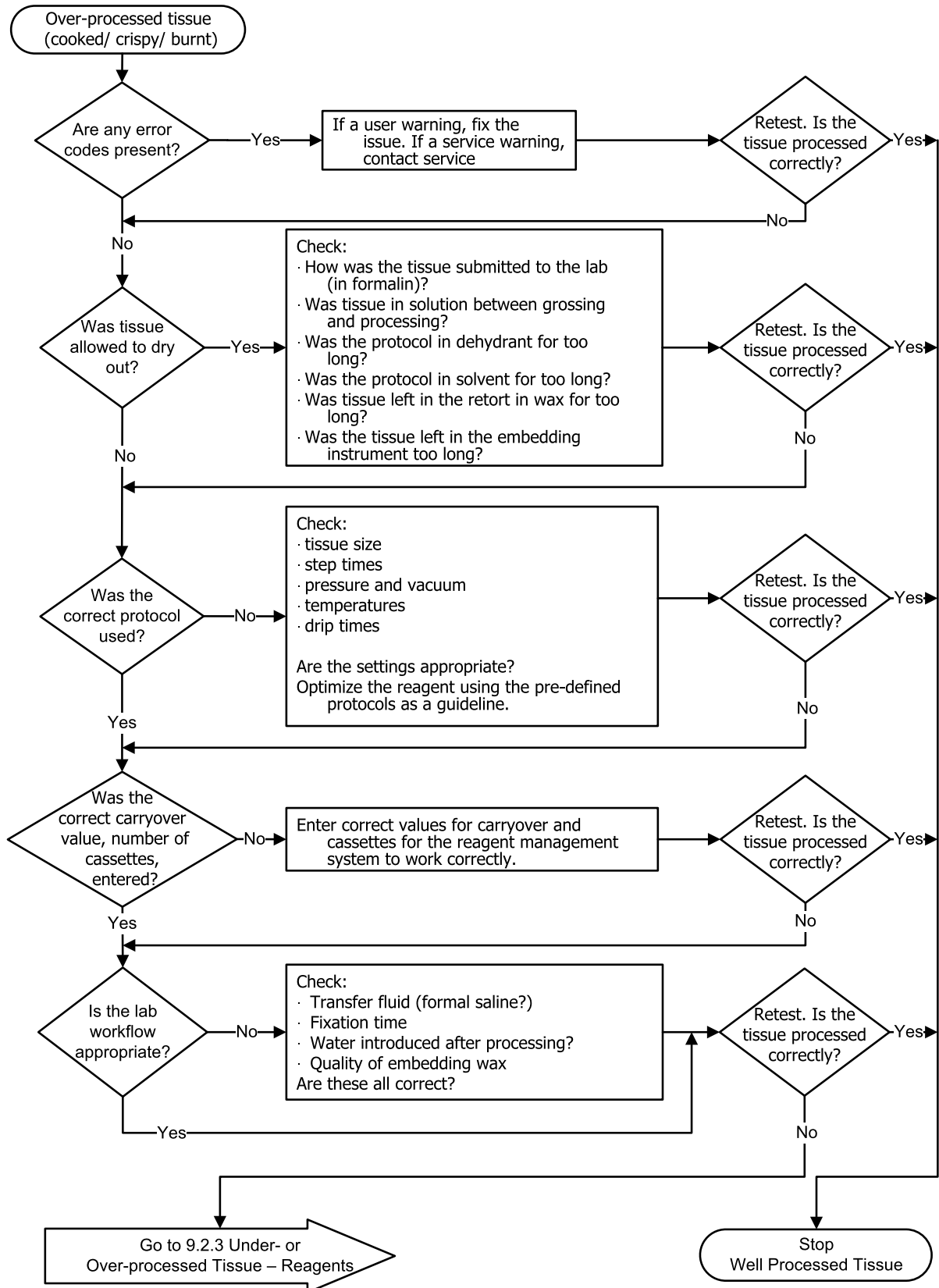

9.2.3 Under- or Over-processed Tissue – Reagents

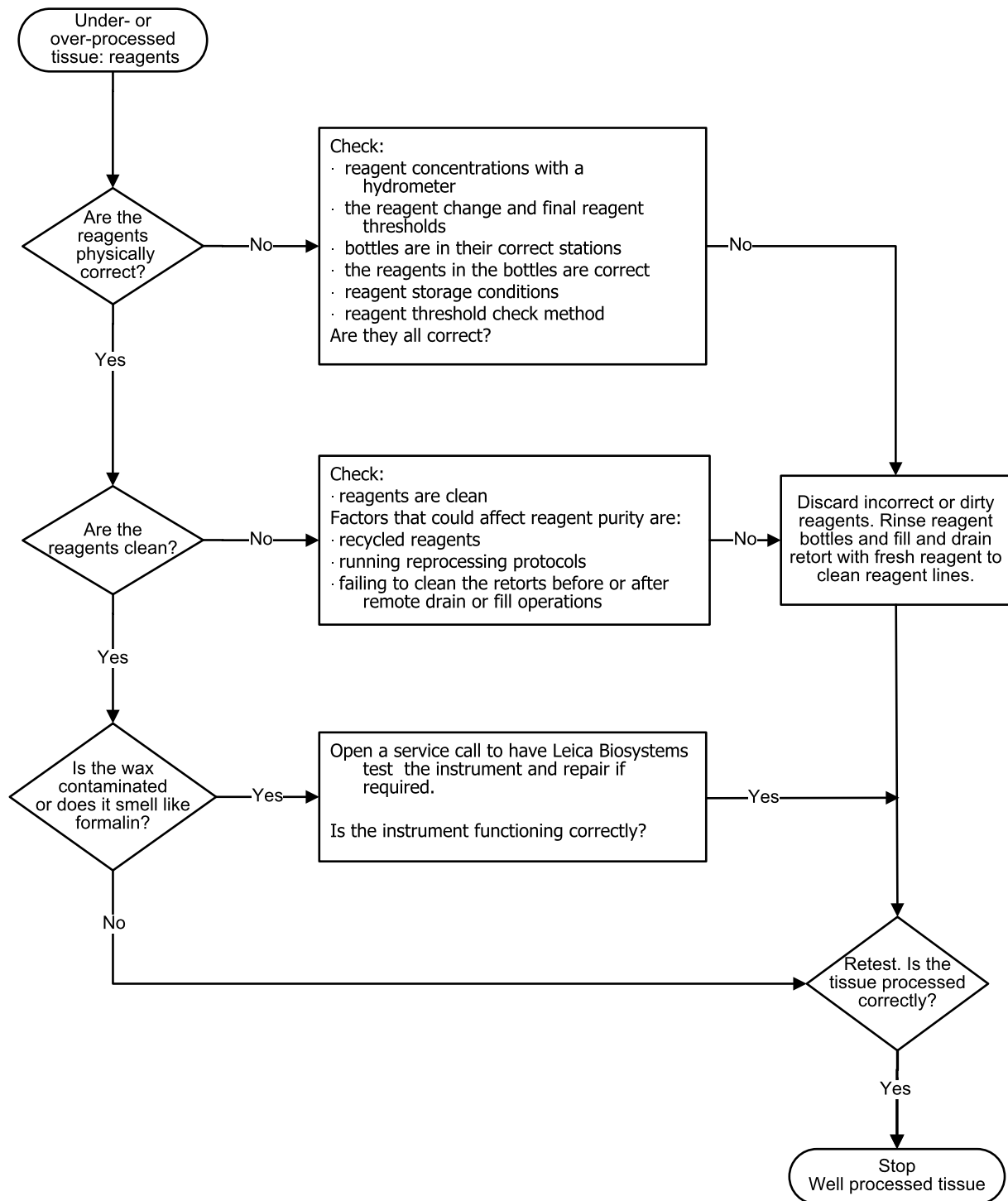

9.2.4 Poor Processing – Incorrect Protocol

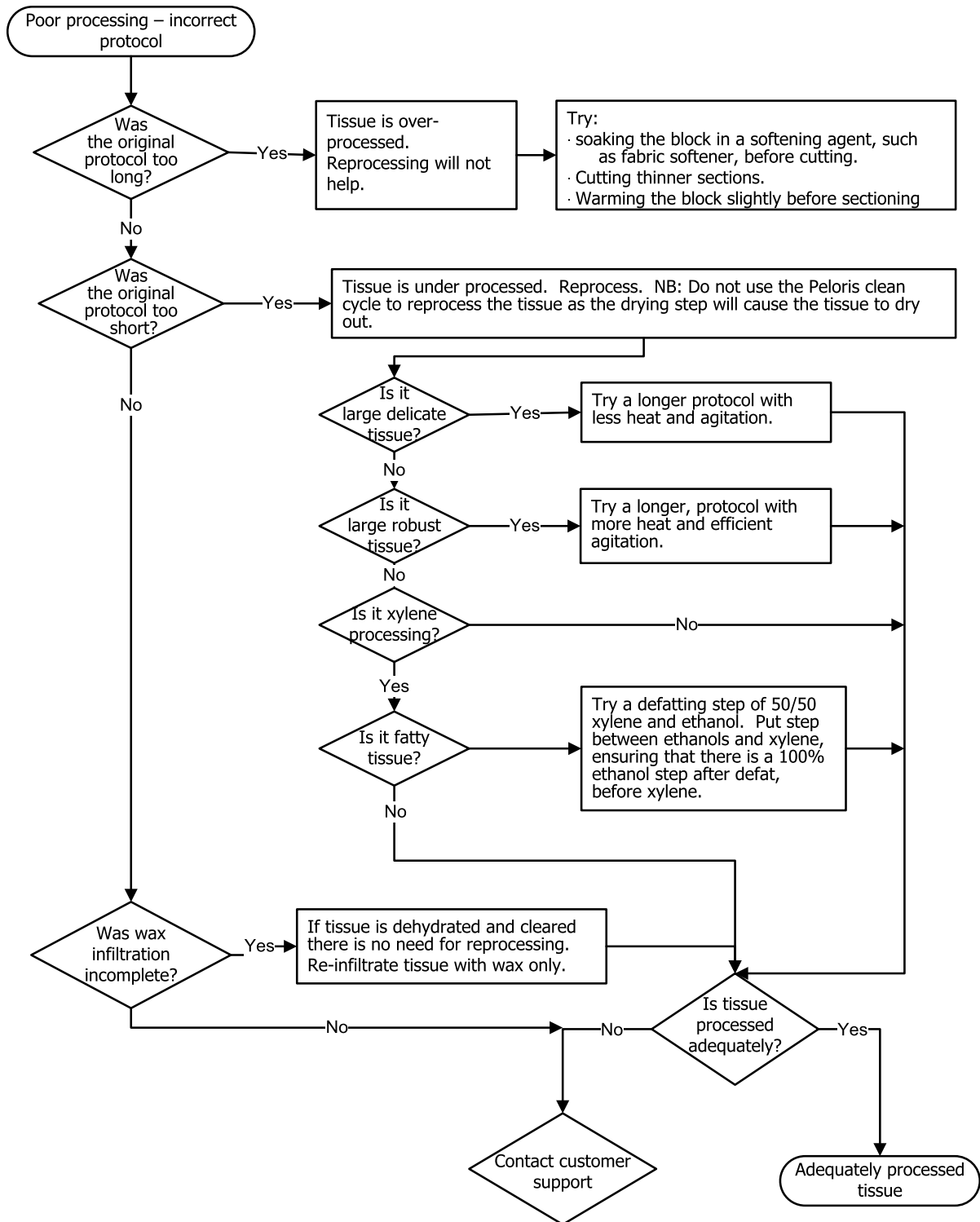

9.2.5 Poor Processing – Correct Protocol

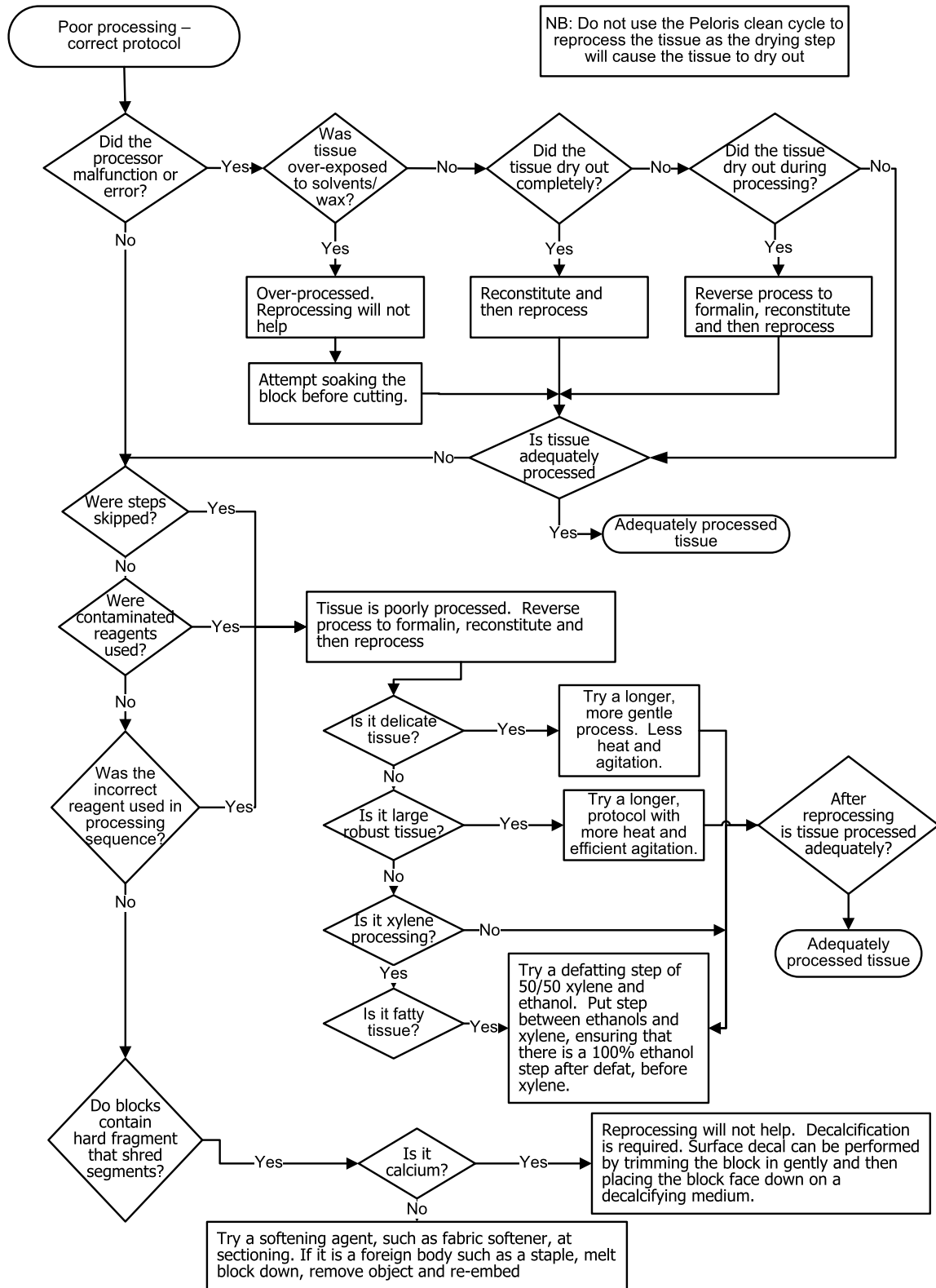

9.2.6 Cutting Artifact

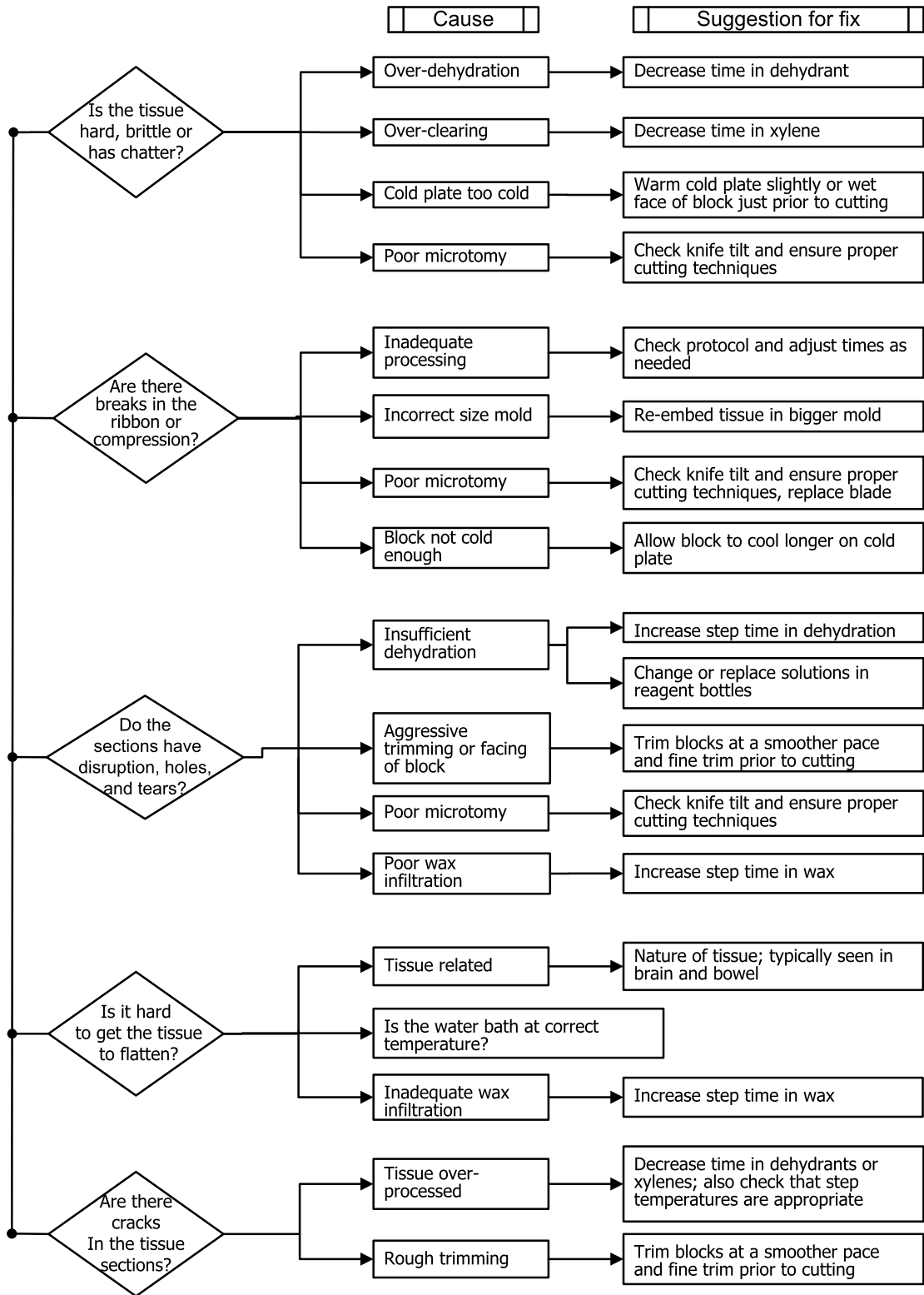

9.2.7 Staining Artifact

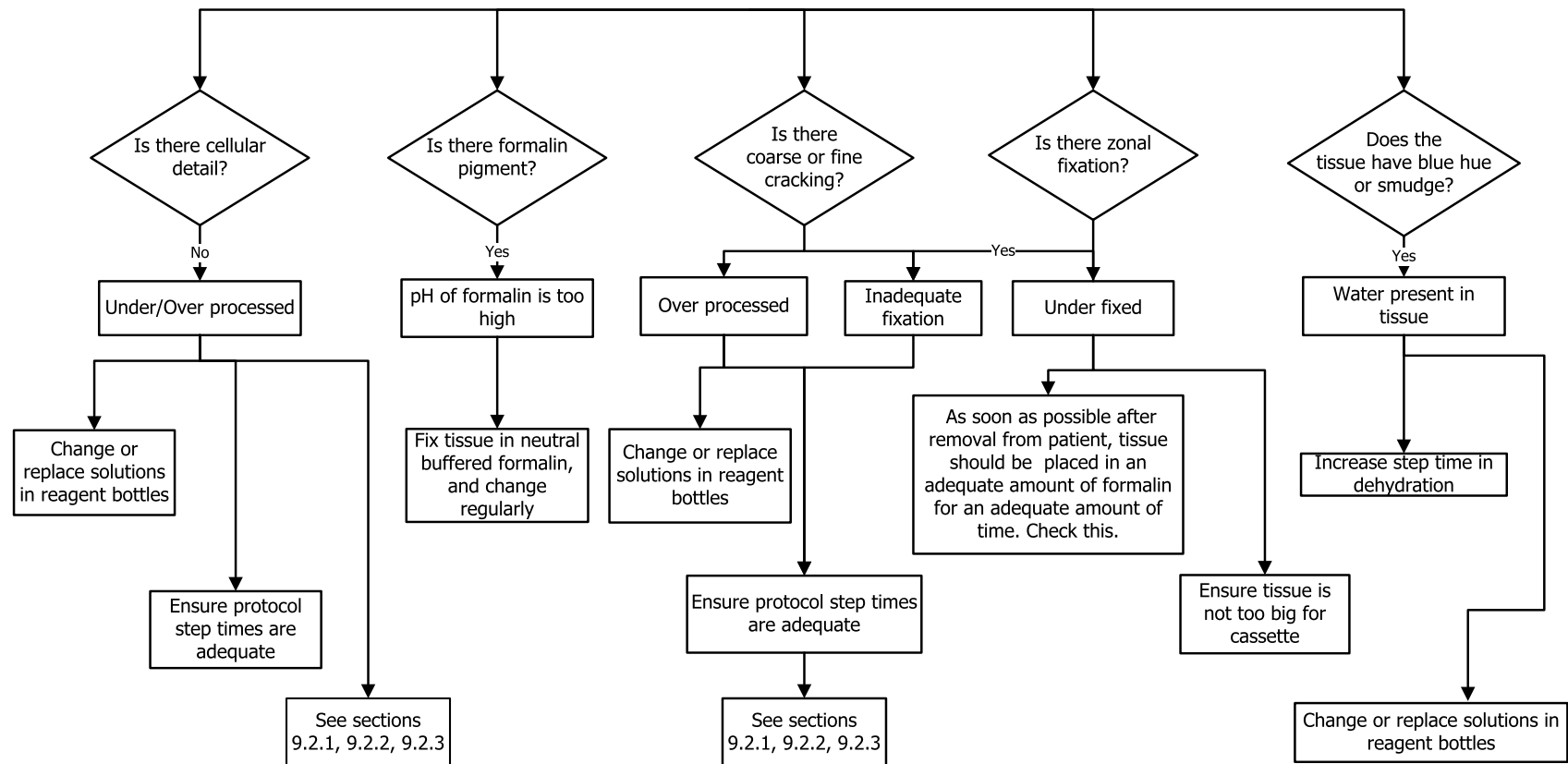

9.2.8 Block Artifact

Always try to ensure that protocol length is correct for the size of the tissue

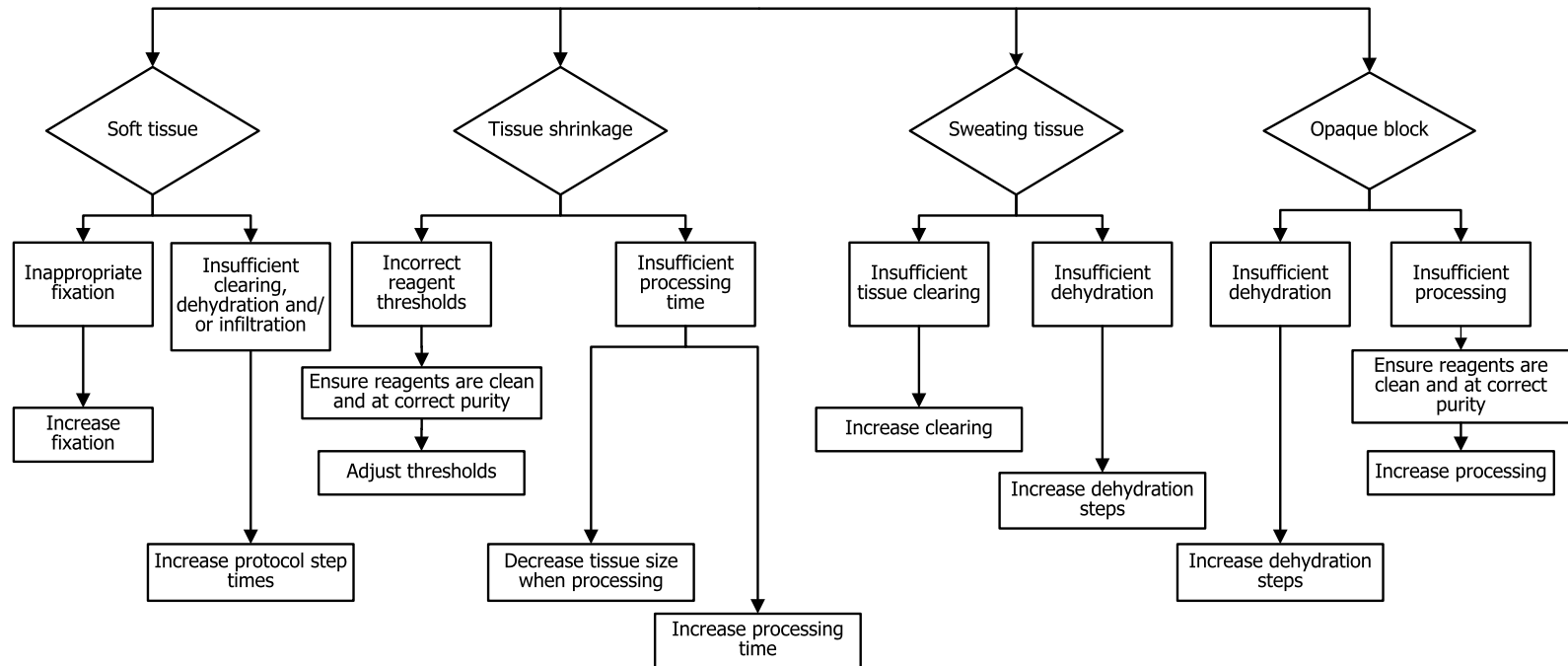

9.3 Reprocessing Recommendations

Not all problem tissue requires reprocessing. Some common problems and possible solutions are discussed in this section.

1. Tough, Brittle, Over-Processed Tissue

Treat the surface of the exposed tissue in the block with a rehydrating or softening agent, such as:

- Melting ice
- 0.2% aqueous Teepol™ or other wetting agent
- Fabric softener at 5% (e.g. Downy™)
- Mollifex™
- 9% glycerol in 60% ethanol

Treat for a few minutes, rinse, rechill and recut.

Reprocessing is inappropriate because it will cause further over-processing.

2. Gritty Tissue Due to Calcium Deposits

Treat the surface of the exposed tissue in the block with a decalcifying agent for 15–30 minutes. (The time depends on the decalcifier used.) Rinse to remove acid, rechill and recut.

Reprocessing tissue that contains calcium or other mineral deposits does not improve its cutting qualities. The calcium must be removed.

3. Hard Shriveled Tissue – Dried Out Before Wax Infiltration

Soak in a large volume of reconstitution solution for 2–24 hours. (The time depends on the size and nature of the tissue and the severity of drying.)

Reconstitution solutions include:

- Neutral buffered formalin
- Isotonic saline
- Sandison's solution
 - 50 mL 1% aqueous formalin
 - 30 mL 96% ethanol
 - 20 mL 5% sodium carbonate
- Ethanol–glycerol
 - 90 mL 60% ethanol
 - 10 mL glycerol

Then process the tissue normally.

4. Hard Shriveled Tissue – Dried Out but Processed Through to Wax

Remove wax and rehydrate as detailed in problem 6, below. Apply a reconstitution solution as described in problem 3.

5. Tissue Insufficiently Infiltrated with Wax

Place the cassettes back into the wax bath with vacuum, stirrer on and temperature at 65°C. This may be necessary when tissue has been prematurely removed from the wax.

6. Adequately Fixed Under-processed Tissue

This problem can be due to too short a protocol, too large a specimen, or processor failure. Four solutions are recommended, but first identify the problem and rectify it. Test your fix by running control tissue through the processor before reprocessing the patient tissue (or use another processor).



Note: For the following solutions, first melt the blocks, blot off excess wax, and then place the specimens in new cassettes. This minimizes wax contaminating the processing reagents.

A. Taggart's Method

Place the cassettes into a beaker of isotonic saline (aqueous solution of 0.9% sodium chloride) in an incubator at 65 °C for 1 hour. The wax rises to the surface. Remove the tissue and reprocess from formalin using a protocol suitable for its size and nature (see [8.2.1 - Specimen Type and Protocol Duration](#)).

The saline gently rehydrates the tissue, which can then be processed normally. Saline is a non-toxic reagent that can be safely used in an open laboratory.

B. Rapid Reverse Process

Process using a fast modified cleaning protocol (see [Rapid Reverse Cleaning Protocol on page 184](#)). Do not use the default Quick Clean protocol or protocols derived from this, because they finish with a drying step that will damage the tissue. After the cleaning protocol, reprocess from formalin using a schedule suitable for the size and nature of the specimen (see [8.2.1 - Specimen Type and Protocol Duration](#)).

Processor cleaning reagents provide a convenient automated method for removing wax and taking the tissue back to alcohol. However, it is a potentially harsher method than methods A or C.

C. Slow Reverse Process

Process using a modified cleaning protocol for a period equal to the time required to forward-process the tissue (see [Slow Reverse Cleaning Protocol on page 184](#)). Then reprocess from formalin using a schedule suitable for the size and nature of the specimen (see [8.2.1 - Specimen Type and Protocol Duration](#)).

A long reverse process is very gentle on the tissue. If time permits, this is the favored option.

D. Direct Reprocessing

In this method, wax is not removed before reprocessing. Place cassettes back into formalin and then, with no other pretreatment, reprocess using a schedule suitable for the size and nature of the specimen (see [8.2.1 - Specimen Type and Protocol Duration](#)).

This method is the quickest. However, it contaminates the reagents with wax. Change all reagents (except wax) after direct reprocessing.

7. Tissue Affected by Formalin During Clearing or Wax Infiltration

This problem can occur if a leaking valve allows formalin to flow into the wax bath. If you see this problem, contact customer support and request that your instrument be tested.

Formalin contamination is characterized by blue hue in the nuclei, loss of chromatin detail, nuclear shrinkage, variable eosinophilia and cytoplasmic swelling and/or shrinkage.

First melt the blocks, blot off excess wax, and then place the specimens in new cassettes. This minimizes wax contaminating the processing reagents. Then reverse-process the blocks by any of the methods listed for problem 6. After this, soak in a high pH Tris-HCl retrieval solution (e.g. BOND Epitope Retrieval Solution 2) for 2–12 hours at room temperature.

This treatment improves the staining qualities of the H&E, the cutting qualities of the tissue and the cohesiveness of the section. Nuclear detail, cytoplasmic swelling and definition are unlikely to improve.

8. Inadequately Fixed, Under-Processed Tissue

A possible remedy is to slowly reverse-process the tissue (see [C. Slow Reverse Process on page 183](#)), apply additional formalin fixation, then reprocess using a schedule suitable for the size and nature of the specimen (see [8.2.1 - Specimen Type and Protocol Duration](#)).

Unfixed or poorly-fixed tissue is damaged by processing. The alcohol and high temperatures exert a fixative effect different to that of formaldehyde. As a result, blocks become more susceptible to hardening and shrinkage. When combined with under-processing, blocks may be unusable.

Rapid Reverse Cleaning Protocol

Step	Reagent type	Time (min)	Temp (°C)	P/V	Stirrer	Drip time (s)
1	Cleaning solvent	12	65	Ambient	High	10
2	Cleaning ethanol	6	55	Ambient	High	10
Processing time:		18				

Slow Reverse Cleaning Protocol

Step	Reagent type	Time (min)	Temp (°C)	P/V	Stirrer	Drip time (s)
1	Cleaning solvent	60	65	Ambient	High	10
2	Cleaning solvent	60	65	Ambient	High	10
3	Cleaning ethanol	60	45	Ambient	High	10
4	Cleaning ethanol	60	45	Ambient	High	10
Processing time:		240				

10. Data Security and Privacy

10.1 Malware Detection

The instrument is equipped with an anti-malware scanner which will scan any inserted USB key. The system will not complete the export or import operation until the anti-malware scan is completed. While the anti-malware scanner is scanning the inserted USB key, the following message will be displayed:

Scanning of USB key in progress (scan time will depend on the contents of the USB key) ...

If no malware is detected, the import/export operation will proceed as normal.

If the anti-malware scanner detects malware on the inserted USB key, the following message will be displayed, and the import or export operation will fail. Please remove the USB key and do not use it.

Malware found on USB key – please remove the USB key and contact your local IT department or your local technical support representative.

Recommendations:

- Use a dedicated USB key for transfers.
- Manage the contents by deleting unnecessary files on the dedicated USB key to minimise scan times.
- If the scan takes longer than expected, remove the USB key (which aborts the scan and transfer) and remove unnecessary files and retry the operation.

10.2 Statement for User Data Security and Privacy

Leica Biosystems respects user data security and privacy and is committed to protecting it. Our Statement for user data security and privacy below will inform you about our policies and procedures concerning the user data that we may collect, use, share and retain.

User Names and Full Names

User account details are encrypted in the data files and retained in the instrument until deleted by a supervisor.

Pictures of Baskets with Cassettes

Pictures of the baskets are collected to track the run details of the cassette in the image. They are encrypted in the data files and retained in the instrument for 60 days. The images are automatically removed from the instrument after 60 days or when the run details reports are purged from the instrument.

11. Specifications

Operating

Dimensions (H x W x D):	1500 × 857 × 721 mm (59 × 33.7 × 28.4 inches)
Weight (dry):	331 kg (730 lb)
Weight (including reagents):	430 kg (950 lb)
Work surface height (from floor):	Front – 1070 mm (42.1 inches) Rear – 1110 mm (43.7 inches)
Cassette capacity (standard protocols):	600 (maximum) 528 (spaced)
Cassette capacity (xylene-free protocols):	432
Retort vacuum (max):	-70 kPa(g)
Retort pressure (max):	+45 kPa(g)
Retort agitation:	Magnetically coupled stirrer (user selectable operation)
Reagent bottles:	16
Reagent volume:	3.8 L (1 US gal) min 5 L (1.32 US gal) max
Paraffin wax stations:	4 (each station is capable of filling one retort)
Service life	7 years.

Environmental

Maximum ambient temperature:	35 °C
Minimum ambient temperature:	5 °C
Humidity (non-condensing):	10 to 80% RH
Altitude:	0 to 2000 m above sea level
Sound pressure level output (at 1 m):	<65 dB
Maximum heating energy output:	1450 W (100 to 120 V~) 2150 W (220 to 240 V~)

Electrical

Operating voltage:	100 to 120 V~ Part Number: 45.0005 220 to 240 V~ Part Number: 45.0001
Operating current (maximum):	15 A (100 to 120 V~) 10 A (220 to 240 V~)
Mains frequency:	50–60 Hz (100 to 120 V~) 50 Hz (220 to 240 V~)
Power consumption:	1450 W (100 to 120 V~) 2150 W (220 to 240 V~)

Transport and Storage

Storage temperature:	–40 to 76 °C (–40 to 169 °F)
Storage humidity (non-condensing):	10 to 95% RH
Shipping methods:	Road and air freight compatible
Equivalent altitude:	<4570 m above sea level (i.e. the pressurization level of an aircraft)



Note: The information in this section is for packaged instruments only. Refer to the **Environmental** section above for unpacked instruments.

Index

A	
abandoning protocols	55
access level	10
setting	121-122
acid clean for retort	153
active reagent types	86
alarms	134
connections	30
power off setting	134
anti-reflection tags	20
ASAP	49
B	
backup files	135
barcode scanner	24
basket	18
biopsy pads, cassettes etc.,carryover from ..	64
bottle	
condensate	23
fill level	16
reagent	22
C	
calcium deposits	182
carbon filter	23
change	150
settings	131
carryover	
default setting	129
general discussion	64
protocol setting	64
cassette basket	18
cassettes	
default number	129
prompt for number	129
cleaning	
protocol	39, 61, 166
reagent bottles	148
retort	143
retort lids	142
top surface	146
wax bath	149
cleaning and maintenance	
schedule	140
compatibility	
reagent	85
tables	170
concentration	
changing	96
management	79, 129
show on Status screen	129
condensate bottle	23
empty	148
Control menu	125
conventional protocols	61
conventional reprocessing protocols	61
copying a protocol	74
creating a new protocol	73

D	
data security and privacy	185
date and time format	132
default number of cassettes	129
default protocol scheduling time	52
delayed end time	58
deleting a protocol	73
density meters	80-81, 88
dormant reagent types	86
draining reagent bottles	102
drip time	60, 132
dying, tissue	85
E	
edit	
protocol	69
protocol for single run	53
reagent types	87
emergency shutdown	14
eosin staining of tissue	85
event severity & color codes	120
external vapor filter	28
F	
factory protocols, list of	157
file transfer	135
fill and drain retorts	111
fill level	
bottles & wax bath	16
set for retorts	132
filter	
carbon	23
change	150
external vapor	28
final reagent thresholds	82
function bar	8
G	
grossing	85
group	
definition	77
selection method	61
H	
heat wax lines	111
HistoCore I-Scan	25, 34, 125
I	
initial fill	58
instrument name, model & serial number ...	125
Instrument settings screen	131
K	
keypads, in software	8
L	
language	132
lid	
cleaning	142
retort	15
lid seal, change	152
liquid level sensors (LLS)	17
local alarm	30
lockout	81

M		protocol	
magnetic stirrer	17	abandoning	55
maintenance		cleaning	39, 61
schedule	140	conventional	61
malware detection	185	copying	74
manual drain drip time	132	delayed end time	58
manual operations	111	delete	73
drip time	132	duration & specimen type	156
wax preheat	112	edit	69
marking, tissue	85	edit for single run	53
melt temperature	130	icon	68
N		initial fill	58
navigation, software	8	list of pre-defined protocols	157
notes, adding to a protocol	35	new	73
O		notes	35
operator	10	overview	60
over-processed tissue		panels	48
instrument problems	175	pausing	55
reagent problems	176	reagent clashes	58
P		reagent selection method	61
pausing protocols	55	save files	66
pre-defined		scheduling	49
protocols	63	selection screen	67
protocols, list	157	set end time	52
reagent types	86	standard	61
preclean purge	41	standard reprocessing	61
predicted end time	49	step temperatures	169
privacy, data	185	types	61
		validation	63
		viewing	75
		xylene-free	61
		xylene-free reprocessing	61

purity thresholds	81	reagent bottles	22
guidelines	154	cleaning	148
		status	43
		reagent station	
		assigning a reagent type	95
		drain	102
		fill and drain	99
		managing	92
		Reagent stations screen	93
		setting concentration	96
		state, set	96
		reagent type	
		definition	78
		edit	87
		managing	86
		recommended reagents	83
		remote alarm	30
		remote fill/drain	99
		draining reagent bottles	102
		reports	114
		reprocessing protocols	
		rapid reverse cleaning protocol	184
		slow reverse cleaning protocol	184
		standard	61
		xylene-free	61
		required end time	49
		retort	15
		acid clean	153
		cleaning	143
		cleaning the lids	142
		default scheduling	52
		empty access temperature	15, 129

last reagent used	129	sound settings	133
liquid level sensors	17	specifications	186
manual drain drip time	132	standard protocols	61
manual operations	111	list of pre-defined	158
replacing seals	152	reprocessing	61
set condition	111	standby temperature	130
stirrer	17	state, station	96
temporary access	56	station	78
vent	16	assigning a reagent type	95
		definition	77
		lockout	81
		managing	92
		selection method	61
		selection rules	62
		set state	96
		station configurations	167
		Status screen	42
		stirrer	17
		removal	143
		supervisor	10
		switching on	14
		T	
		Taggart's method	183
		temperature thresholds	83
		thresholds, reagent	80
		final reagent	82
		purity	81
		reagent change	81
		temperature	83
		time and date format	132
		tissue dying	85

